

# **iDEN and WiDEN Measurement Guide**

**(iDEN with MotoTalk)**

**Agilent Technologies E4406A VSA Series  
Transmitter Tester**

**Option HN1**



**Agilent Technologies**

**Manufacturing Part Number: E4406-90260  
Supersedes E4406-90129**

**Printed in USA**

**December 2004**

© Copyright 1999 - 2004 Agilent Technologies, Inc.

The information contained in this document is subject to change without notice.

Agilent Technologies makes no warranty of any kind with regard to this material, including but not limited to, the implied warranties of merchantability and fitness for a particular purpose. Agilent Technologies shall not be liable for errors contained herein or for incidental or consequential damages in connection with the furnishing, performance, or use of this material.

<b>1. Understanding iDEN, WiDEN, and MotoTalk</b>	
What is iDEN . . . . .	20
What is WiDEN . . . . .	20
What is MotoTalk . . . . .	22
What Does the E4406A VSA Series Transmitter Tester Do? . . . . .	23
Other Sources of Measurement Information . . . . .	24
Instrument Updates at <a href="http://www.agilent.com/find/vsa">http://www.agilent.com/find/vsa</a> . . . . .	24
<b>2. Setting Up the iDEN or WiDEN Mode</b>	
Mode . . . . .	26
How to Make a Measurement . . . . .	26
Changing the Mode Setup . . . . .	26
Changing the Frequency Channel . . . . .	31
Installing Optional Measurement Personalities . . . . .	32
Do You Have Enough Memory to Load All Your Personality Options? . . . . .	32
How to Predict Your Memory Requirements . . . . .	33
Loading an Optional Measurement Personality . . . . .	35
Obtaining and Installing a License Key . . . . .	35
Viewing a License Key . . . . .	36
Using the Uninstall Key on E4406A . . . . .	36
Ordering Optional Measurement Personalities . . . . .	37
<b>3. Making iDEN or WiDEN Measurements</b>	
iDEN or WiDEN Measurements . . . . .	40
Preparing for Measurements . . . . .	41
Initial Setup . . . . .	41
Measure Control . . . . .	41
Measurement Setup . . . . .	42
Making the Adjacent Channel Power Measurement . . . . .	45
Mode Availability . . . . .	45
Purpose . . . . .	45
Measurement Method . . . . .	45
Making the Measurement . . . . .	46
Results . . . . .	46
Changing the Measurement Setup . . . . .	48
Troubleshooting Hints . . . . .	50
Making the Bit Error Rate Measurement . . . . .	52
Mode Availability . . . . .	52
Purpose . . . . .	52
Measurement Method . . . . .	52
Making the Measurement . . . . .	54
Results . . . . .	54
Changing the Measurement Setup . . . . .	56
Making the Occupied Bandwidth Measurement . . . . .	58
Mode Availability . . . . .	58
Purpose . . . . .	58
Measurement Method . . . . .	58
Making the Measurement . . . . .	58

---

# Contents

Results .....	59
Changing the Measurement Setup .....	60
Making the Power Versus Time Measurement .....	62
Mode Availability .....	62
Purpose .....	62
Measurement Method .....	62
Making the Measurement .....	63
Results .....	63
Changing the Measurement Setup .....	66
Changing the View .....	67
Troubleshooting Hints .....	67
Making the MotoTalk Average Power (MT Avg Pwr) Measurement .....	68
Mode Availability .....	68
Purpose .....	68
Measurement Method .....	68
Making the Measurement .....	68
Results .....	69
Changing the Measurement Setup .....	69
Using the Markers .....	71
Troubleshooting Hints .....	73
Making the MotoTalk Transient EVM (MT Trans EVM) Measurement .....	74
Mode Availability .....	74
Purpose .....	74
Measurement Method .....	74
Making the Measurement .....	74
Results .....	75
Changing the Measurement Setup .....	75
Using the Markers .....	76
Troubleshooting Hints .....	78
Making the Spectrum (Frequency Domain) Measurement .....	79
Mode Availability .....	79
Purpose .....	79
Measurement Method .....	79
Making the Measurement .....	79
Results .....	80
Changing the Measurement Setup .....	81
Changing the View .....	85
Using the Markers .....	85
Troubleshooting Hints .....	86
Making the Waveform (Time Domain) Measurement .....	87
Mode Availability .....	87
Purpose .....	87
Measurement Method .....	87
Making the Measurement .....	87
Results .....	88
Changing the Measurement Setup .....	89
Changing the View .....	91
Using the Markers .....	91
Troubleshooting Hints .....	93

<b>4. iDEN and WiDEN Specifications</b>	
Measurements	97
Frequency	99
General	100
<b>5. iDEN Programming Commands</b>	
SCPI Command Subsystems	102
CALCulate Subsystem	103
Adjacent Channel Power—Limit Test	103
Bit Error Rate—Error Limit	103
Bit Error Rate—Limit Testing	103
Query the Current Measurement Status	104
Data Query	104
Calculate/Compress Trace Data Query	104
Calculate Peaks of Trace Data	109
CALCulate:MARKers Subsystem	110
Occupied Bandwidth - Limits	120
Power vs. Time—Carrier Measurement	122
Power vs. Time—Limit Test	122
CONFigure Subsystem	124
DISPlay Subsystem	125
Turn the Display On/Off	125
Select Display Format	125
PVT - View Selection	125
Spectrum - Y-Axis Reference Level	126
Turn a Trace Display On/Off	127
Waveform - Y-Axis Reference Level	131
FETCh Subsystem	133
FORMat Subsystem	134
Byte Order	134
Numeric Data Format	134
INITiate Subsystem	136
Take New Data Acquisition for Selected Measurement	136
Continuous or Single Measurements	136
Take New Data Acquisitions	137
Restart the Measurement	137
MEASure Group of Commands	138
Measure Commands	138
Configure Commands	139
Fetch Commands	140
Read Commands	140
Adjacent Channel Power Ratio (ACPR) Measurement	141
Bit Error Rate Measurement	151
Occupied Bandwidth Measurement	155
Power vs. Time Measurement	157
MotoTalk Average Power (MT Avg Pwr) Measurement	162
MotoTalk Transient EVM (MT Trans EVM) Measurement	163
Spectrum (Frequency Domain) Measurement	164
Waveform (Time Domain) Measurement	166

---

# Contents

READ Subsystem .....	168
SENSE Subsystem .....	169
Adjacent Channel Power Measurement .....	169
Correction for Base Station RF Port External Attenuation .....	189
Correction for Mobile Station RF Port External Attenuation .....	190
Occupied Bandwidth Measurement .....	191
RF Port Power Range Auto .....	193
Power vs. Time Measurement .....	194
MotoTalk Average Power (MT Avg Pwr) Measurement .....	204
MotoTalk Transient Error Vector Magnitude (MT Trans EVM) Measurement .....	208
RF Port Input Attenuation .....	211
RF Port Power Range Maximum Total Power .....	212
Radio Setup .....	213
Spectrum (Frequency-Domain) Measurement .....	217
Burst Sync Delay .....	228
Burst Search Threshold .....	228
Waveform (Time-Domain) Measurement .....	229
Bit Error Rate Measurement .....	234

---

# List of Commands

:CALCulate:<measurement>:MARKer:AOff	111
:CALCulate:<measurement>:MARKer[1]   2   3   4:FUNctIon BPOWer   NOISe   OFF	111
:CALCulate:<measurement>:MARKer[1]   2   3   4:FUNctIon:RESult?	112
:CALCulate:<measurement>:MARKer[1]   2   3   4:FUNctIon?	111
:CALCulate:<measurement>:MARKer[1]   2   3   4:IQ?	112
:CALCulate:<measurement>:MARKer[1]   2   3   4:MAXimum	113
:CALCulate:<measurement>:MARKer[1]   2   3   4:MINimum	113
:CALCulate:<measurement>:MARKer[1]   2   3   4:MODE POSition   DELTA	114
:CALCulate:<measurement>:MARKer[1]   2   3   4:MODE?	114
:CALCulate:<measurement>:MARKer[1]   2   3   4:TRACe <trace_name>	114
:CALCulate:<measurement>:MARKer[1]   2   3   4:TRACe?	115
:CALCulate:<measurement>:MARKer[1]   2   3   4:X <param>	119
:CALCulate:<measurement>:MARKer[1]   2   3   4:X:POSition <integer>	119
:CALCulate:<measurement>:MARKer[1]   2   3   4:X:POSition?	119
:CALCulate:<measurement>:MARKer[1]   2   3   4:X?	119
:CALCulate:<measurement>:MARKer[1]   2   3   4:Y?	120
:CALCulate:<measurement>:MARKer[1]   2   3   4[:STATe] OFF   ON   0   1	114
:CALCulate:<measurement>:MARKer[1]   2   3   4[:STATe]?	114
:CALCulate:ACP:LIMit:STATe OFF   ON   0   1	103
:CALCulate:ACP:LIMit:STATe?	103
:CALCulate:BER:LIMit:ERATe <percent>	103
:CALCulate:BER:LIMit:ERATe?	103
:CALCulate:BER:LIMit:STATe OFF   ON   0   1	103
:CALCulate:BER:LIMit:STATe?	103
:CALCulate:CLIMits:FAIL?	104
:CALCulate:DATA[n]:COMPRESS? MAXimum   MEAN   MINimum   RMS   SAMPlE   SDEVia- tion   CFIT {,<soffset>},{<length>},{<roffset>}	104
:CALCulate:DATA[n]:PEAKs? <threshold>,<excursion>[,AMPLitude   FREQuency   TIME]	109
:CALCulate:DATA[n]?	104
:CALCulate:OBW:LIMit:FBLimit <freq>	120
:CALCulate:OBW:LIMit:FBLimit?	120

---

# List of Commands

:CALCulate:OBW:LIMit[:TEST] OFF   ON   0   1	121
:CALCulate:OBW:LIMit[:TEST]?	121
:CALCulate:OBWidth:LIMit:FBLimit <freq>	120
:CALCulate:OBWidth:LIMit:FBLimit?	120
:CALCulate:OBWidth:LIMit:STATe OFF   ON   0   1	121
:CALCulate:OBWidth:LIMit:STATe?	122
:CALCulate:PVTime:CARRier[:SElect] ALL   C0   C1   C2   C3	122
:CALCulate:PVTime:CARRier[:SElect]?	122
:CALCulate:PVTime:LIMit:STATe OFF   ON   0   1	122
:CALCulate:PVTime:LIMit:STATe?	122
:CONFigure:<measurement>	124
:CONFigure:ACPR	141
:CONFigure:APOWer	162
:CONFigure:BER	151
:CONFigure:OBW	155
:CONFigure:PVTime	157
:CONFigure:SPECTrum	164
:CONFigure:TEVM	163
:CONFigure:WAVEform	166
:DISPlay:ENABle OFF   ON   0   1	125
:DISPlay:ENABle?	125
:DISPlay:FORMat:ZOOM	125
:DISPlay:PVTime:VIEW ALL   BOTH	126
:DISPlay:PVTime:VIEW ALL   BOTH   A   B   C   D   E	126
:DISPlay:PVTime:VIEW?	126
:DISPlay:SPECTrum[n]:WINDow[m]:TRACe:Y[:SCALe]:RLEVel <power>	126
:DISPlay:SPECTrum[n]:WINDow[m]:TRACe:Y[:SCALe]:RLEVel?	126
:DISPlay:TRACe[n][:STATe] OFF   ON   0   1	127
:DISPlay:TRACe[n][:STATe]?	127
:DISPlay:WAVEform[n]:WINDow[m]:TRACe:Y[:SCALe]:RLEVel <power>	131
:DISPlay:WAVEform[n]:WINDow[m]:TRACe:Y[:SCALe]:RLEVel?	131



---

# List of Commands

:FETCh:<measurement>[n]? .....	133
:FETCh:ACPR[n]? .....	141
:FETCh:APOWer[n]? .....	162
:FETCh:BER[n]? .....	151
:FETCh:OBW[n]? .....	155
:FETCh:PVTime[n]? .....	157
:FETCh:SPECtrum[n]? .....	164
:FETCh:TEVM[n]? .....	163
:FETCh:WAVeform[n]? .....	166
:FORMat:BORDER NORMal   SWAPped .....	134
:FORMat:BORDER? .....	134
:FORMat[:DATA] ASCii   REAL,32   REAL,64. ....	134
:FORMat[:DATA]? .....	134
:INITiate:<measurement> .....	136
:INITiate:BER. ....	151
:INITiate:CONTinuous OFF   ON   0   1 .....	136
:INITiate:CONTinuous? .....	136
:INITiate:OBW .....	155
:INITiate:PVTime .....	157
:INITiate:REStart .....	137
:INITiate[:IMMediate] .....	137
:MEASure:<measurement>[n]? .....	138
:MEASure:ACPR[n]? .....	141
:MEASure:APOWer[n]? .....	162
:MEASure:BER[n]? .....	151
:MEASure:OBW[n]? .....	155
:MEASure:PVTime[n]? .....	157
:MEASure:SPECtrum[n]? .....	164
:MEASure:TEVM[n]? .....	163
:MEASure:WAVeform[n]? .....	166
:READ:<measurement>[n]? .....	168

---

# List of Commands

:READ:ACPR[n]? .....	141
:READ:APOWer[n]? .....	162
:READ:BER[n]? .....	151
:READ:OBW[n]? .....	155
:READ:PVTime[n]? .....	157
:READ:SPECTrum[n]? .....	164
:READ:TEVM[n]? .....	163
:READ:WAVeform[n]? .....	166
[:SENSe]:ACP:AVERAge:COUNT <integer> .....	169
[:SENSe]:ACP:AVERAge:COUNT? .....	169
[:SENSe]:ACP:AVERAge:TCONtrol EXPonential   REPeat .....	170
[:SENSe]:ACP:AVERAge:TCONtrol? .....	170
[:SENSe]:ACP:AVERAge[:STATe] OFF   ON   0   1 .....	169
[:SENSe]:ACP:AVERAge[:STATe]? .....	169
[:SENSe]:ACP:BANDwidth[n]   BWIDth[n]:INTegration <freq> .....	170
[:SENSe]:ACP:BANDwidth[n]   BWIDth[n]:INTegration? .....	170
[:SENSe]:ACP:BANDwidth[n]   BWIDth[n]:INTegration[m] <freq> .....	170
[:SENSe]:ACP:BANDwidth[n]   BWIDth[n]:INTegration[m]? .....	170
[:SENSe]:ACP:BANDwidth   BWIDth:INTegration <freq> .....	170
[:SENSe]:ACP:BANDwidth   BWIDth:INTegration? .....	170
[:SENSe]:ACP:OFFSet:ABSolute <power> .....	173
[:SENSe]:ACP:OFFSet:ABSolute? .....	173
[:SENSe]:ACP:OFFSet:BANDwidth   BWIDth <res_bw> .....	175
[:SENSe]:ACP:OFFSet:BANDwidth   BWIDth <res_bw> .....	175
[:SENSe]:ACP:OFFSet:BANDwidth   BWIDth? .....	175
[:SENSe]:ACP:OFFSet:BANDwidth   BWIDth? .....	175
[:SENSe]:ACP:OFFSet:LIST:ABSolute <power>,<power> .....	173
[:SENSe]:ACP:OFFSet:LIST:ABSolute <power>,<power>,<power>,<power>,<power> .....	173
[:SENSe]:ACP:OFFSet:LIST:ABSolute? .....	173
[:SENSe]:ACP:OFFSet:LIST:ABSolute? .....	173
[:SENSe]:ACP:OFFSet:LIST:BANDwidth   BWIDth	

# List of Commands

<res_bw>,<res_bw>,<res_bw>,<res_bw>,<res_bw> . . . . .	175
[:SENSe]:ACP:OFFSet:LIST:BANDwidth   BWIDth? . . . . .	175
[:SENSe]:ACP:OFFSet:LIST:RCARrier <rel_power>,<rel_power> . . . . .	182
[:SENSe]:ACP:OFFSet:LIST:RCARrier <rel_power>,<rel_power>,<rel_power>,<rel_power>,<rel_power> . . . . .	182
[:SENSe]:ACP:OFFSet:LIST:RCARrier? . . . . .	182
[:SENSe]:ACP:OFFSet:LIST:RCARrier? . . . . .	182
[:SENSe]:ACP:OFFSet:LIST:RPSDensity <rel_powr>,<rel_powr>,<rel_powr>,<rel_powr>,<rel_powr> . . . . .	184
[:SENSe]:ACP:OFFSet:LIST:RPSDensity? . . . . .	184
[:SENSe]:ACP:OFFSet:LIST:TEST ABSolute   AND   OR   RELative, ABSolute   AND   OR   RELative, ABSolute   AND   OR   RELative, ABSolute   AND   OR   RELative, ABSolute   AND   OR   RELative . . . . .	186
[:SENSe]:ACP:OFFSet:LIST:TEST? . . . . .	186
[:SENSe]:ACP:OFFSet:LIST[:FREQuency] <f_offset>,<f_offset> . . . . .	178
[:SENSe]:ACP:OFFSet:LIST[:FREQuency] <f_offset>,<f_offset>,<f_offset>,<f_offset>,<f_offset> . . . . .	178
[:SENSe]:ACP:OFFSet:LIST[:FREQuency]? . . . . .	178
[:SENSe]:ACP:OFFSet:LIST[:FREQuency]? . . . . .	178
[:SENSe]:ACP:OFFSet:RCARrier <rel_power> . . . . .	181
[:SENSe]:ACP:OFFSet:RCARrier? . . . . .	181
[:SENSe]:ACP:OFFSet:RPSDensity <rel_power> . . . . .	184
[:SENSe]:ACP:OFFSet:RPSDensity? . . . . .	184
[:SENSe]:ACP:OFFSet:TEST ABSolute   AND   OR   RELative . . . . .	186
[:SENSe]:ACP:OFFSet:TEST? . . . . .	186
[:SENSe]:ACP:OFFSet[:FREQuency] <f_offset> . . . . .	178
[:SENSe]:ACP:OFFSet[:FREQuency]? . . . . .	178
[:SENSe]:ACP:OFFSet[n]:LIST:ABSolute <power>,<power>,<power>,<power>,<power> . . . . .	173
[:SENSe]:ACP:OFFSet[n]:LIST:ABSolute? . . . . .	173
[:SENSe]:ACP:OFFSet[n]:LIST:BANDwidth   BWIDth <res_bw>,<res_bw>,<res_bw>,<res_bw>,<res_bw> . . . . .	175
[:SENSe]:ACP:OFFSet[n]:LIST:BANDwidth   BWIDth? . . . . .	175

---

# List of Commands

[:SENSe]:ACP:OFFSet[n]:LIST:RCARrier <rel_power>,<rel_power>,<rel_power>,<rel_power>,<rel_power>.....	182
[:SENSe]:ACP:OFFSet[n]:LIST:RCARrier? .....	182
[:SENSe]:ACP:OFFSet[n]:LIST:TEST ABSolute   AND   OR   RELative, ABSolute   AND   OR   RELative, ABSolute   AND   OR   RELative, ABSolute   AND   OR   RELative, ABSolute   AND   OR   RELative.....	186
[:SENSe]:ACP:OFFSet[n]:LIST:TEST? .....	186
[:SENSe]:ACP:OFFSet[n]:LIST[:FREQuency] <f_offset>,<f_offset>,<f_offset>,<f_offset>,<f_offset>.....	179
[:SENSe]:ACP:OFFSet[n]:LIST[:FREQuency]? .....	179
[:SENSe]:ACP:OFFSet[n]:LIST[n]:BANDwidth   BWIDth <res_bw>,<res_bw>,<res_bw>,<res_bw>,<res_bw> .....	176
[:SENSe]:ACP:OFFSet[n]:LIST[n]:BANDwidth   BWIDth?.....	176
[:SENSe]:ACP:OFFSet[n]:LIST[n]:RCARrier <rel_power>,<rel_power>,<rel_power>,<rel_power>,<rel_power>.....	182
[:SENSe]:ACP:OFFSet[n]:LIST[n]:RCARrier?.....	182
[:SENSe]:ACP:OFFSet[n]:LIST[n]:RPSDensity <rel_powr>,<rel_powr>,<rel_powr>,<rel_powr>,<rel_powr> .....	184
[:SENSe]:ACP:OFFSet[n]:LIST[n]:RPSDensity?.....	184
[:SENSe]:ACP:OFFSet[n]:LIST[n]:TEST, ABSolute   AND   OR   RELative, ABSolute   AND   OR   RELative, ABSolute   AND   OR   RELative, ABSolute   AND   OR   RELative... 186	
[:SENSe]:ACP:OFFSet[n]:LIST[n]:TEST? .....	186
[:SENSe]:ACP:OFFSet[n]:LIST[n][:FREQuency] <f_offset>,<f_offset>,<f_offset>,<f_offset>,<f_offset>.....	179
[:SENSe]:ACP:OFFSet[n]:LIST[n][:FREQuency]?.....	179
[:SENSe]:ACP:SPECTrum:ENABle OFF   ON   0   1 .....	187
[:SENSe]:ACP:SPECTrum:ENABle? .....	187
[:SENSe]:ACP:TRIGger:SOURce EXTernal[1]   EXTernal2   FRAME   IF   IMMEDIATE   RFBurst ..	189
[:SENSe]:ACP:TRIGger:SOURce?.....	189
[:SENSe]:APOWer:AVERage:COUNt <integer> .....	204
[:SENSe]:APOWer:AVERage:COUNt? .....	204
[:SENSe]:APOWer:AVERage[:STATe] OFF   ON   0   1 .....	204
[:SENSe]:APOWer:AVERage[:STATe]?.....	204
[:SENSe]:APOWer:BANDwidth   BWIDth[:RESolution] <bandwidth> .....	205

# List of Commands

[:SENSe]:APOWer:BAWdth   BWIDth[:RESolution]:TYPE FLATtop   GAUSSian	205
[:SENSe]:APOWer:BAWdth   BWIDth[:RESolution]:TYPE?	205
[:SENSe]:APOWer:BAWdth   BWIDth[:RESolution]?	205
[:SENSe]:APOWer:BiDMethod RFAmplitude   SWORd	205
[:SENSe]:APOWer:BiDMethod?	205
[:SENSe]:APOWer:DECimation:STATe OFF   ON   0   1	206
[:SENSe]:APOWer:DECimation:STATe?	206
[:SENSe]:APOWer:DECimation[:FACTor] <integer>	206
[:SENSe]:APOWer:DECimation[:FACTor]?	206
[:SENSe]:APOWer:MEASure BURst   GATEd   GBURst	207
[:SENSe]:APOWer:MEASure?	207
[:SENSe]:APOWer:SWEep:TIME <integer>	208
[:SENSe]:APOWer:SWEep:TIME?	208
[:SENSe]:APOWer:TRIGger:SOURce IMMEDIATE   RFBURst   VIDEO   EXTERNAL[1]   EXTERNAL2	208
[:SENSe]:APOWer:TRIGger:SOURce?	208
[:SENSe]:BER:AVERage:TCONtrol EXPONENTIAL   REPEAT	234
[:SENSe]:BER:AVERage:TCONtrol?	234
[:SENSe]:BER:BAWdth   BWIDth[:RESolution] <freq>	234
[:SENSe]:BER:BAWdth   BWIDth[:RESolution]?	234
[:SENSe]:BER:FRAMES <integer>	235
[:SENSe]:BER:FRAMES?	235
[:SENSe]:BER:PVTTest OFF   ON   0   1	235
[:SENSe]:BER:PVTTest?	235
[:SENSe]:BER:SLOTs <integer>	235
[:SENSe]:BER:SLOTs?	235
[:SENSe]:BER:TRIGger:SOURce EXTERNAL[1]   EXTERNAL2   FRAME   IF   IMMEDIATE   RFBURst	236
[:SENSe]:BER:TRIGger:SOURce?	236
[:SENSe]:CORRection:BS[:RF]:LOSS <rel_power>	189
[:SENSe]:CORRection:BS[:RF]:LOSS?	189
[:SENSe]:CORRection:MS[:RF]:LOSS <rel_power>	190
[:SENSe]:CORRection:MS[:RF]:LOSS?	190

---

# List of Commands

[:SENSe]:OBW:AVERAge:COUNT <integer> .....	191
[:SENSe]:OBW:AVERAge:COUNT? .....	191
[:SENSe]:OBW:AVERAge:TCONtrol EXPONential   REPEAT .....	192
[:SENSe]:OBW:AVERAge:TCONtrol? .....	192
[:SENSe]:OBW:AVERAge[:STATe] OFF   ON   0   1 .....	191
[:SENSe]:OBW:AVERAge[:STATe]? .....	191
[:SENSe]:OBW:TRIGger:SOURce EXTernal[1]   EXTernal2   IF   IMMEDIATE   RFBURSt .....	193
[:SENSe]:OBWidth:PERCent <number> .....	192
[:SENSe]:OBWidth:PERCent? .....	192
[:SENSe]:OBWidth:TRIGger:SOURce? .....	193
[:SENSe]:POWer[:RF]:ATTenuation <rel_power> .....	211
[:SENSe]:POWer[:RF]:ATTenuation? .....	211
[:SENSe]:POWer[:RF]:RANGe:AUTO OFF   ON   0   1 .....	193
[:SENSe]:POWer[:RF]:RANGe:AUTO? .....	193
[:SENSe]:POWer[:RF]:RANge[:UPPer] <power> .....	212
[:SENSe]:POWer[:RF]:RANge[:UPPer]? .....	212
[:SENSe]:PVTIme:AVERAge:COUNT <integer> .....	194
[:SENSe]:PVTIme:AVERAge:COUNT? .....	194
[:SENSe]:PVTIme:AVERAge:TYPE LOG   MAXimum   MINimum   MXMinimum   RMS .....	194
[:SENSe]:PVTIme:AVERAge:TYPE LOG   MAXimum   MINimum   MXMinimum   RMS   POWER ..	194
[:SENSe]:PVTIme:AVERAge:TYPE LOG   MAXimum   MINimum   RMS   SCALar .....	195
[:SENSe]:PVTIme:AVERAge:TYPE RMS   MAXimum   MINimum .....	195
[:SENSe]:PVTIme:AVERAge:TYPE? .....	195
[:SENSe]:PVTIme:BANDwidth   BWIDth[:RESolution] <freq> .....	195
[:SENSe]:PVTIme:BANDwidth   BWIDth[:RESolution]:TYPE FLATtop   GAUSSian .....	196
[:SENSe]:PVTIme:BANDwidth   BWIDth[:RESolution]:TYPE? .....	196
[:SENSe]:PVTIme:BANDwidth   BWIDth[:RESolution]? .....	195
[:SENSe]:PVTIme:CESTimate:[TIME] <time> .....	196
[:SENSe]:PVTIme:CESTimate:[TIME]? .....	196
[:SENSe]:PVTIme:MASK:LIST:LOWer:ABSolute <power>, <power>, <power>, <power>, <power> ..	197

# List of Commands

[:SENSe]:PVTime:MASK:LIST:LOWer:ABSolute?	197
[:SENSe]:PVTime:MASK:LIST:LOWer:POINts?	198
[:SENSe]:PVTime:MASK:LIST:LOWer:RELative <rel_power>, <rel_power>, <rel_power>, <rel_power>, <rel_power>	198
[:SENSe]:PVTime:MASK:LIST:LOWer:RELative?	198
[:SENSe]:PVTime:MASK:LIST:LOWer:TIME <seconds>, <seconds>, <seconds>, <seconds>, <seconds>	198
[:SENSe]:PVTime:MASK:LIST:LOWer:TIME?	199
[:SENSe]:PVTime:MASK:LIST:UPPer:ABSolute <power>, <power>, <power>, <power>, <power>	199
[:SENSe]:PVTime:MASK:LIST:UPPer:ABSolute?	199
[:SENSe]:PVTime:MASK:LIST:UPPer:POINts?	200
[:SENSe]:PVTime:MASK:LIST:UPPer:RELative <rel_power>, <rel_power>, <rel_power>, <rel_power>, <rel_power>	200
[:SENSe]:PVTime:MASK:LIST:UPPer:RELative?	200
[:SENSe]:PVTime:MASK:LIST:UPPer:TIME <seconds>, <seconds>, <seconds>, <seconds>, <seconds>	202
[:SENSe]:PVTime:MASK:LIST:UPPer:TIME?	202
[:SENSe]:PVTime:MASK:SElect STANDard   CUSTom	203
[:SENSe]:PVTime:MASK:SElect?	203
[:SENSe]:PVTime:TRIGger:SOURce EXTernal[1]   EXTernal2   FRAMe   LINE   IF   IMMEDIATE   RFBurst	203
[:SENSe]:PVTime:TRIGger:SOURce?	203
[:SENSe]:RADio:CARRier:NUMBer SINGle   MULTiple	214
[:SENSe]:RADio:CARRier:NUMBer?	214
[:SENSe]:RADio:CARRier[:TYPE] AUTO   I25   I50   O50   I75   I100	213
[:SENSe]:RADio:CARRier[:TYPE]:ACTual?	213
[:SENSe]:RADio:CARRier[:TYPE]?	213
[:SENSe]:RADio:CCODE <integer>	214
[:SENSe]:RADio:CCODE?	214
[:SENSe]:RADio:DEVice INBound   OUTBound	214
[:SENSe]:RADio:DEVice?	214
[:SENSe]:RADio:FORMat M16QAM   M64QAM   DMCA   DJSMr	216

---

# List of Commands

[:SENSe]:RADio:FORMat? .....	216
[:SENSe]:RADio:SLOT:INBound TCHFull   TCHS31   TCHS31T   TCHE61 .....	216
[:SENSe]:RADio:SLOT:INBound? .....	216
[:SENSe]:RADio:SLOT:OUTBound TCHFull   TCHS31   TCHS31T   TCHE61 .....	217
[:SENSe]:RADio:SLOT:OUTBound? .....	217
[:SENSe]:SPECTrum:ACQuisition:PACKing AUTO   LONG   MEDium   SHORt .....	218
[:SENSe]:SPECTrum:ACQuisition:PACKing? .....	218
[:SENSe]:SPECTrum:ADC:DITHer[:STATe] AUTO   ON   OFF   2   1   0 .....	218
[:SENSe]:SPECTrum:ADC:DITHer[:STATe]? .....	218
[:SENSe]:SPECTrum:ADC:RANGe AUTO   APEak   APLOCK   M6   P0   P6   P12   P18   P24   NONE .....	218
[:SENSe]:SPECTrum:ADC:RANGe? .....	218
[:SENSe]:SPECTrum:AVERAge:CLEAr .....	219
[:SENSe]:SPECTrum:AVERAge:COUNT <integer> .....	219
[:SENSe]:SPECTrum:AVERAge:COUNT? .....	219
[:SENSe]:SPECTrum:AVERAge:TCONtrol EXPOntial   REPeat .....	220
[:SENSe]:SPECTrum:AVERAge:TCONtrol? .....	220
[:SENSe]:SPECTrum:AVERAge:TYPE LOG   MAXimum   MINimum   RMS   SCALAr .....	221
[:SENSe]:SPECTrum:AVERAge:TYPE? .....	221
[:SENSe]:SPECTrum:AVERAge[:STATe] OFF   ON   0   1 .....	220
[:SENSe]:SPECTrum:AVERAge[:STATe]? .....	220
[:SENSe]:SPECTrum:BANDwidth   BWIDth:PADC OFF   ON   0   1 .....	221
[:SENSe]:SPECTrum:BANDwidth   BWIDth:PADC? .....	221
[:SENSe]:SPECTrum:BANDwidth   BWIDth:PFFT:AUTO OFF   ON   0   1 .....	221
[:SENSe]:SPECTrum:BANDwidth   BWIDth:PFFT:AUTO? .....	221
[:SENSe]:SPECTrum:BANDwidth   BWIDth:PFFT:TYPE FLAT   GAUSsian .....	222
[:SENSe]:SPECTrum:BANDwidth   BWIDth:PFFT:TYPE? .....	222
[:SENSe]:SPECTrum:BANDwidth   BWIDth:PFFT[:SIZE] <freq> .....	221
[:SENSe]:SPECTrum:BANDwidth   BWIDth:PFFT[:SIZE]? .....	222
[:SENSe]:SPECTrum:BANDwidth   BWIDth[:RESolution] <freq> .....	222
[:SENSe]:SPECTrum:BANDwidth   BWIDth[:RESolution]:AUTO OFF   ON   0   1 .....	223
[:SENSe]:SPECTrum:BANDwidth   BWIDth[:RESolution]:AUTO? .....	223



# List of Commands

[:SENSe]:SPECTrum:BAWdwidth   BWIDth[:RESolution]?	222
[:SENSe]:SPECTrum:DECimate[:FACTor] <integer>	223
[:SENSe]:SPECTrum:DECimate[:FACTor]?	223
[:SENSe]:SPECTrum:FFT:LENGth <integer>	224
[:SENSe]:SPECTrum:FFT:LENGth:AUTO OFF   ON   0   1	224
[:SENSe]:SPECTrum:FFT:LENGth?	224
[:SENSe]:SPECTrum:FFT:RBWPoints <real>	224
[:SENSe]:SPECTrum:FFT:WINDow:LENGth <integer>	226
[:SENSe]:SPECTrum:FFT:WINDow:LENGth?	226
[:SENSe]:SPECTrum:FFT:WINDow[:TYPE] BH4Tap   BLACKman   FLATtop   GAUSSian   HAm-Ming   HANNing   KB70   KB90   KB110   UNIForm	226
[:SENSe]:SPECTrum:FFT:WINDow[:TYPE]?	226
[:SENSe]:SPECTrum:FREQuency:SPAN <freq>	227
[:SENSe]:SPECTrum:FREQuency:SPAN?	227
[:SENSe]:SPECTrum:TRIGger:SOURce EXTernal[1]   EXTernal 2   FRAMe   IF   LINE   IMMEDIATE   RFBurst	227
[:SENSe]:SPECTrum:TRIGger:SOURce?	227
[:SENSe]:SPECTrum:FFT:LENGth:AUTO?	224
[:SENSe]:SPECTrum:FFT:RBWPoints?	224
[:SENSe]:SYNC:BURSt:DELay <time>	228
[:SENSe]:SYNC:BURSt:DELay?	228
[:SENSe]:SYNC:STHReshold <rel_power>	228
[:SENSe]:SYNC:STHReshold?	228
[:SENSe]:TEVM:BAWdwidth   BWIDth:RESolution:TYPE FLATtop   GAUSSian	209
[:SENSe]:TEVM:BAWdwidth   BWIDth:RESolution:TYPE?	209
[:SENSe]:TEVM:BAWdwidth   BWIDth[:RESolution]?	210
[:SENSe]:TEVM:DECimation:STATe OFF   ON   0   1	211
[:SENSe]:TEVM:DECimation:STATe?	211
[:SENSe]:TEVM:DECimation[:FACTor] <integer>	210
[:SENSe]:TEVM:DECimation[:FACTor]?	210
[:SENSe]:TEVM:FOFFset <freq>	209
[:SENSe]:TEVM:FOFFset?	209

---

# List of Commands

[[:SENSE]:TEVM:TRIGger:SOURce IMMEDIATE   RFBURST   EXTERNAL[1]   EXTERNAL2 . . . . .	209
[[:SENSE]:TEVM:TRIGger:SOURce? . . . . .	209
[[:SENSE]:WAVEform:ADC:FILTer:[[:STATE] OFF   ON   0   1. . . . .	229
[[:SENSE]:WAVEform:ADC:FILTer:[[:STATE]? . . . . .	229
[[:SENSE]:WAVEform:ADC:RANGe AUTO   APEak   APLOCK   GROund   M6   P0   P6   P12   P18   P24   . 229	
[[:SENSE]:WAVEform:ADC:RANGe? . . . . .	229
[[:SENSE]:WAVEform:AVERAge:COUNT <integer>. . . . .	230
[[:SENSE]:WAVEform:AVERAge:COUNT?. . . . .	230
[[:SENSE]:WAVEform:AVERAge:TCONtrol EXPonential   REPeat . . . . .	230
[[:SENSE]:WAVEform:AVERAge:TCONtrol?. . . . .	230
[[:SENSE]:WAVEform:AVERAge:TYPE LOG   MAXimum   MINimum   RMS   SCALar . . . . .	231
[[:SENSE]:WAVEform:AVERAge:TYPE? . . . . .	231
[[:SENSE]:WAVEform:AVERAge:[[:STATE] OFF   ON   0   1 . . . . .	230
[[:SENSE]:WAVEform:AVERAge:[[:STATE]? . . . . .	230
[[:SENSE]:WAVEform:BANDwidth   BWIDth[:RESolution] <freq>. . . . .	231
[[:SENSE]:WAVEform:BANDwidth   BWIDth[:RESolution]:TYPE FLATtop   GAUSSian . . . . .	232
[[:SENSE]:WAVEform:BANDwidth   BWIDth[:RESolution]:TYPE? . . . . .	232
[[:SENSE]:WAVEform:BANDwidth   BWIDth[:RESolution]? . . . . .	231
[[:SENSE]:WAVEform:DECimate:STATE OFF   ON   0   1 . . . . .	232
[[:SENSE]:WAVEform:DECimate:STATE? . . . . .	232
[[:SENSE]:WAVEform:DECimate[:FACTor] <integer>. . . . .	232
[[:SENSE]:WAVEform:DECimate[:FACTor]? . . . . .	232
[[:SENSE]:WAVEform:SWEep:TIME <time> . . . . .	233
[[:SENSE]:WAVEform:SWEep:TIME? . . . . .	233
[[:SENSE]:WAVEform:TRIGger:SOURce EXTERNAL[1]   EXTERNAL2   FRAME   IF   IMMEDIATE   LINE   RFBURST. . . . .	233
[[:SENSE]:WAVEform:TRIGger:SOURce?. . . . .	233

---

**1 Understanding iDEN, WiDEN,  
and MotoTalk**

---

## What is iDEN

Option HN1 adds iDEN (Motorola's Integrated Digital Enhanced Network) capability to the Agilent Technologies E4406A. iDEN is a trademark of the Motorola Company. This chapter introduces you to the iDEN measurement personality. For instructions on how to install the option, see [“Installing Optional Measurement Personalities” on page 32](#).

The iDEN standard combines four communication technologies into a single network: radio, telephone, messaging, and data communications capabilities. The system uses TDMA in a QAM modulation format with multiple-carriers (M-QAM.) The modulated signal consists of four frequency division multiplexed sub-channels, each carrying a 16-QAM or 64-QAM signal. The sub-channel approach allows you to use a lower symbol rate which provides resistance to time dispersion.

Option HN1 adds the following measurements:

- The **ACP** key measures adjacent channel power ratio.
- The **BER** key measures bit error rate.
- The **OBW** key measures occupied power bandwidth.
- The **Power vs. Time** key measures transmit power.
- The **Spectrum** key measures standard spectrum analyzer signals in the frequency domain.
- The **Waveform** key measures standard spectrum analyzer signals in the time domain.
- The **Avg Pwr** key measures the average transmit power of normal (traffic) bursts.
- The **Trans EVM** key measures modulation accuracy, carrier offset, and VCO settle time when frequency is hopping between two frequencies.

Option HN1 operates the same as other analyzer options. This documentation describes option specific information. Refer to the standard instrument manuals for descriptions of other functionality.

## What is WiDEN

The WiDEN mode expands the current iDEN measurement capabilities to perform additional signal analysis for the WiDEN Reserved Access inbound slot format.

WiDEN is similar to iDEN Enhanced 6:1 format in the following ways:

- Both slot formats use the same symbol mapping
- Both slot formats use the same sync and pilot definitions
- Both slot formats use the same BER test sequence. However, in WiDEN the same sequence of BER words is transmitted on all active

carriers. However, the sequence starting point is offset from carrier to carrier. For example, when four carriers are transmitted the sequence transmitted on each carrier is offset by four words from the previous carrier. In this case the BER word sequence transmitted in four active slots (possibly separated by inactive slots) would be:

- Carrier 0 word sequence: 0, 1, 2, 3
- Carrier 1 word sequence: 4, 5, 6, 7
- Carrier 2 word sequence: 8, 9, a, b
- Carrier 3 word sequence: c, d, e, f

- Both slot formats are 15 ms long

WiDEN is dissimilar to iDEN Enhanced 6:1 format in the following ways:

- WiDEN allows 1 to 4 25 kHz carriers
- WiDEN allows arbitrary slots within a frame to be active
- The training sequence is different between the two slot formats
- The training waveform is DC centered with respect to the composite signal and may or may not be present. For WiDEN this means that the training waveform is often not centered with respect to any given carrier.
- WiDEN adds an SGC pulse for the benefit of the base station at a point in time where there is no data or any other information being transmitted by the mobile. WiDEN can simultaneously transmit up to four carriers at 25 kHz spacing.

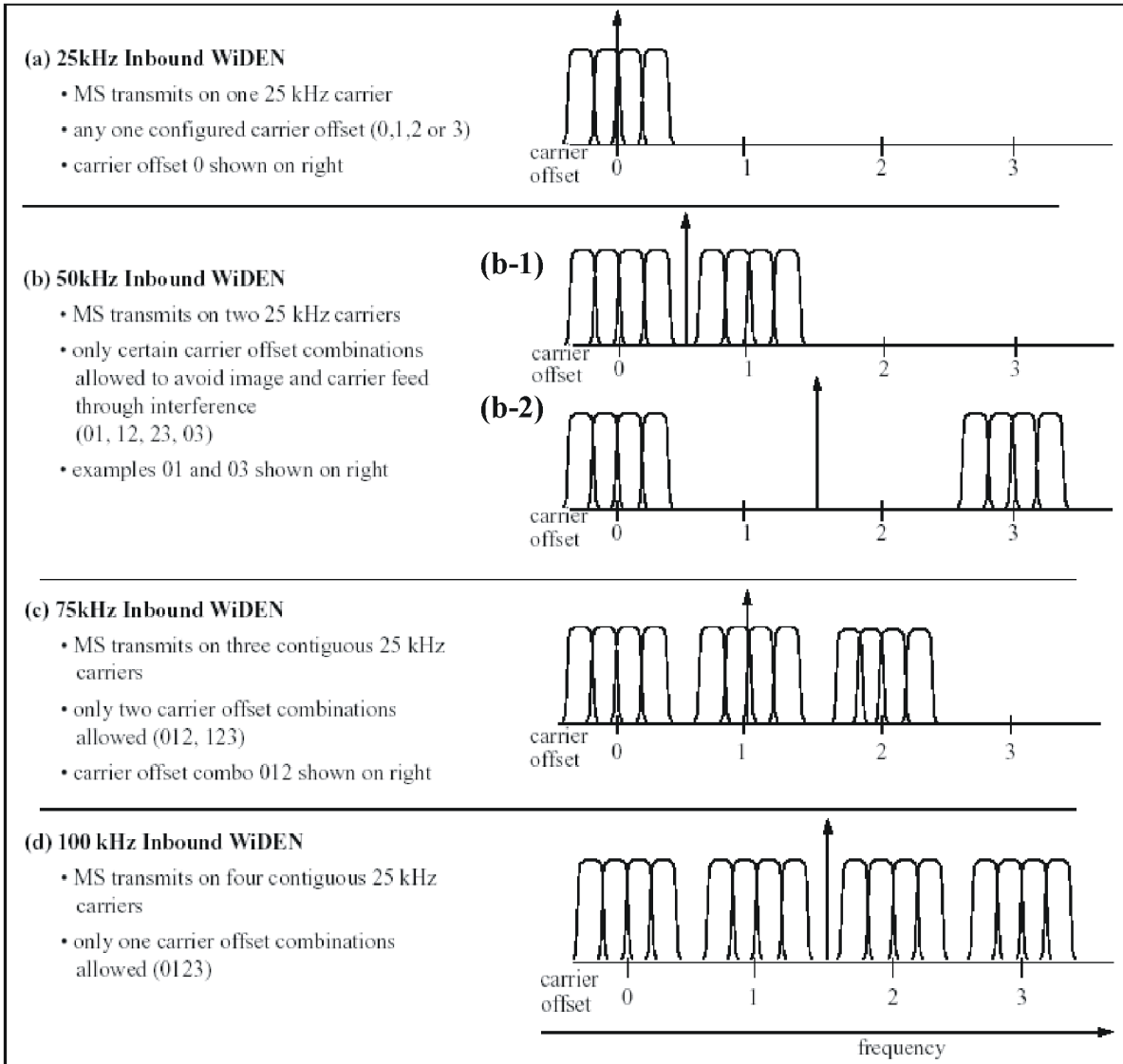
You can perform WiDEN signal analysis under any of the allowed carrier combinations. When multiple carriers are present, all carriers will be analyzed at the same time.

The WiDEN mode supports the following measurements for 16-QAM Modulation Type:

- Occupied BW
- ACPR
- Burst Power
- BER

There are five distinct carrier configurations for WiDEN inbound signals. These configurations are shown in [Figure 1-1](#).

**Figure 1-1 WiDEN Inbound Carrier Configurations**



## What is MotoTalk

MotoTalk is a trademark of Motorola Company. It supports mobile-to-mobile communications between a pair or group of MotoTalk radios on a single logical channel in simplex fashion (walkie-talkie). MotoTalk uses 8-FSK modulation format. Because MotoTalk is deployed in the 900 MHz Industrial, Scientific, and Medical (ISM) band, frequency hopping rules governed by FCC regulations are followed.

---

## What Does the E4406A VSA Series Transmitter Tester Do?

The E4406A VSA Series Transmitter Tester makes measurements that conform to the Motorola iDEN standards specifications.

This standards document defines complex multi-part measurements, like occupied power bandwidth. The E4406A automatically makes these measurements using the measurement methods and limits defined in the standard. The detailed results displayed when the measurements are made, allow you to analyze iDEN system performance. You may alter the measurement parameters for specialized analysis.

With Option HN1 installed, you can run measurements on an iDEN signal. Selecting the iDEN **Mode** key automatically configures the instrument to measure iDEN signals. For example, selecting iDEN sets the default adjacent channel bandwidth (for the adjacent channel power test) to 10 kHz.

Base stations can be tested in a number of ways. One of the most common is to take the signal from the antenna input or from the base station power amp output. This can be done using a splitter or coupler and external attenuator.

To measure iDEN signals you must first select the iDEN mode and choose the mode setup parameters. Some of the modes setup choices include measuring both inbound and outbound signals for different standards and in M-16QAM, M-64QAM, or D-JSMR. The mode setup defaults to measuring the inbound (mobiles) signal path. Mode settings are used in all the measurements. You can then select the desired measurement and change any of the measurement-specific setup parameters that you want to alter from the default settings. Refer to the following chapters for information on the measurement process.

## Other Sources of Measurement Information

Additional measurement application information is available through your local Agilent Technologies sales and service office. The following application notes treat digital communications measurements in much greater detail than discussed in this measurement guide.

- Application Note  
Characterizing Digitally Modulated Signals with CCDF Curves  
5968-6875E
- Application Note 1314  
Testing and Troubleshooting Digital RF Communications Receiver  
Designs 5968-3579E
- Application Note 1313  
Testing and Troubleshooting Digital RF Communications  
Transmitter Designs 5966-3578E

### Instrument Updates at <http://www.agilent.com/find/vsa>

This web location can be used to access the latest information about the transmitter tester.



---

---

**2****Setting Up the iDEN or WiDEN  
Mode**

## Mode

You may want to install a new personality or reinstall a personality that you had previously. Instructions can be found in “[Installing Optional Measurement Personalities](#)” on page 32.

At the initial power up, the transmitter tester will come up in the Basic mode, with the Spectrum (Frequency Domain) measurement selected and the Measure menu displayed.

To access the iDEN measurement personality press the **Mode** key and select the **iDEN** menu key. To access the WiDEN measurement personality press the **Mode** key and select the **WiDEN** menu key.

If you want to set the mode to a known, factory default state, press **Preset**. This will preset the mode setup and all of the measurements to the factory default parameters. These defaults are based on iDEN M-16QAM, M-64QAM, or D-JSMR specifications and WiDEN M-16QAM specifications. Preset defaults to the inbound (mobiles) signal path.

### NOTE

Pressing the **Preset** key does not switch instrument modes.

Mode settings are persistent. When you switch from one mode to another mode, the settings you originally selected for the mode will remain active until you change them. This allows you to switch back and forth between modes without having to reset settings each time. Presetting the instrument or powering the instrument off and on will return all mode settings to their default values.

## How to Make a Measurement

The “making measurements” information is organized to help you follow the three-step process shown in the table below.

Step	Primary Key	Setup Keys	Related Keys
1. Select & setup a mode	<b>MODE</b>	<b>Mode Setup, Input, FREQUENCY Channel</b>	<b>System</b>
2. Select & setup a measurement	<b>MEASURE</b>	<b>Meas Setup</b>	<b>Meas Control, Restart</b>
3. Select & setup a view	<b>View/Trace</b>	<b>SPAN X Scale, AMPLITUDE Y Scale, Next Window, Zoom</b>	<b>File, Save, Print, Print Setup, Marker, Search</b>

## Changing the Mode Setup

Numerous settings can be changed at the mode level by pressing the

**Mode Setup** key. This will access the selection menu listed below. These settings affect only the measurements in the iDEN mode.

### Radio

The **Radio** key accesses the iDEN menu as follows:

- **QAM format** - Selects the modulation format of M-16QAM, M-64QAM, or D-JSMR.
- **Device** - Sets the test device to inbound (mobile station) or outbound (base station). The base station must be put in the test mode to transmit known bit patterns, before testing.
- **Outbound Slot** - Sets the outbound test signal format to:
  - **Full Slot** - Reserved.
  - **Split 3:1** - Reserved.
- **Inbound Slot** - Sets the inbound test signal format to:
  - **Full Slot** - Reserved.
  - **Split 3:1** - Res Pseudo.
  - **Split 3:1** - Res Training.
  - **Full Slot** - Enhanced 6:1.
- **Color Code (0-95)** - Used to define the sync and plot symbols

The **Radio** key accesses the iDEN and WiDEN menu as follows:

The **Radio** key accesses the WiDEN menu as follows:

- **Carrier Config** - Used to define carrier configuration

Radio Default Settings	iDEN	WiDEN
QAM format	M16QAM	N/A
Device	Inbound	N/A
Inbound Slot	Full Slot Reserved	N/A
Color Code	39	39

### Input

The **Input** key accesses the menu as follows: (You can also access this menu from the front-panel **Input** key.)

- **RF Input Range** - Allows you to toggle the RF input range between **Auto** and **Man (manual)**. **Auto** is not used for spectrum measurements. If **Auto** is chosen, the instrument automatically takes data to determine the proper attenuator setting, based on the carrier power level where it is tuned. Once you change the **Max Total Pwr** or

**Input Atten** value with the **RPG** knob, for example, the **RF Input Range** key is automatically set to **Man**. You may need to set the **RF Input Range** to **Man** and enter the expected maximum total power by activating the **Max Total Pwr** key. **Man** is also useful to hold the input attenuation constant for the best relative power accuracy. It is generally recommended to set this to **Auto**. This key is not available in the Spectrum measurement.

- **Max Total Pwr** - Allows you to set the maximum mean carrier power from the UUT (Unit Under Test). The range is  $-100.00$  to  $+27.70$  dBm with 0.01 dB resolution. This is the expected maximum value of the mean carrier power referenced to the output of the UUT. The **Max Total Pwr** setting is coupled together with the **Input Atten** and **Ext Atten** settings. Once you change the **Max Total Pwr** value with the **RPG** knob, for example, the **RF Input Range** key is automatically set to **Man**.
- **Input Atten** - Allows you to control the input attenuator setting. The range is 0 to 40 dB with 1 dB resolution. The **Input Atten** key reads out the actual hardware value that is used for the current measurement. If more than one input attenuator value is used in a single measurement, the value used at the carrier frequency will be displayed. The **Input Atten** setting is coupled together with the **Max Total Pwr** setting. Once you change the **Input Atten** value with the **RPG** knob, for example, the **RF Input Range** key is automatically set to **Man**.

---

**NOTE**

The **Max Total Pwr** and **Input Atten** settings are coupled together, so for a given measurement, changing the input **Max Total Pwr** setting by x dB changes the **Input Atten** setting by x dB, and vice-versa. When you switch to a different measurement, the **Max Total Pwr** setting is kept constant, but the **Input Atten** may change if the two measurements have different mixer margins. Thus, you can directly set the transmitter tester input attenuator, or you can set it indirectly by specifying the expected maximum power from the UUT.

---

- **Ext Atten** - Allows you to enter the external attenuation value for the mobile station. The range is  $-50.00$  to  $+100.00$  dB with 0.01 dB resolution. This will allow the instrument to display the measurement results referred to the output of the UUT.
- **IF Align Signal** - Allows you to modify the IF alignment signal.

**Signal Rate** - Changes the rate of the IF alignment signal. You must enter a divider number from 1 to 12. Each divider number increment halves the signal frequency. For example, at the default DAC setting of 1 the signal is set to 234.375 kHz. If the rate is set to 2 the signal is half that frequency, or 117.188 kHz.

**Signal Amptd** - Modifies the signal amplitude by entering a DAC value between 0 - 4095. The amplitude range is approximately 50

dB. Incrementing the DAC value increases the amplitude of the signal, and will be visible on screen.

**Signal Type** - Allows you to select a CW, comb, or pulse type signal as the IF align signal.

<b>Input Default Settings</b>	
RF input range	Auto <sup>a</sup>
Maximum total power	-15.0 dBm <sup>b</sup>
Input attenuation	0 dB <sup>b</sup>
External attenuation M.S.	0.00 dB

a. Auto is not used for spectrum measurements.

b. In auto mode, the maximum total power and the input attenuation will increase from the defaults, if the input power is more than 0 dBm.

### Trigger

The **Trigger** key (available under the **Mode Setup, Trigger**) allows you: (1) to access the **RF Burst (Wideband)**, **Video (IF Envlp)**, **Ext Front** and **Ext Rear** trigger source selection menu to specify the triggering conditions for each trigger source, (2) to modify the default trigger holdoff time using the **Trig Holdoff** key, (3) to modify the auto trigger time and to activate or deactivate the **Auto Trigger** feature using the **Auto Trig** key, and (4) to modify the period of the frame timer using the **Frame Timer** key.

---

#### NOTE

---

The actual trigger source is selected separately for each measurement under the **Meas Setup** key.

- **RF Burst (Wideband)**, **Video (IF Envlp)**, **Ext Front** and **Ext Rear** - Pressing one of these trigger keys will access each triggering condition setup menu. This menu is used to specify the **Delay**, **Level** and **Slope** settings for each trigger source as follows:

**Delay** - Allows you to enter numerical values to modify the delay time. The range is -500.000 to +500.000 ms with 1 ns resolution. For trigger delay use a positive value, and for pre-trigger use a negative value.

**Level** - Allows you to enter a numerical value to adjust the trigger level depending on the trigger source selected.

- For **RF Burst** selection, the RF level range is -25.00 to 0.00 dB with 0.01 dB resolution, relative to the peak RF signal level.
- For **Video** selection, the video level range is -200.00 to +50.00 dBm with 0.01 dB resolution at the RF input. The realistic range can be down to around -40 dBm, depending on the noise

level of the signal.

- For **Ext Front** or **Ext Rear** selection, the level range is  $-5.00$  to  $+5.00$  V with 1 mV resolution.

**Slope Pos Neg** - Allows you to toggle the trigger slope between **Pos** at the positive-going edge and **Neg** at the negative-going edge of the burst signal.

Other keys accessed under the **Trigger** menu key:

- **Trig Holdoff** - Allows you to set the period of time before the next trigger can occur. The range is 0.000 to 500 ms with 1  $\mu$ s resolution.
- **Auto Trig** - Allows you to specify a time for a trigger timeout. The range is 1.0 ms to 10 sec with 1  $\mu$ s resolution. If no trigger occurs by the specified time, a trigger is automatically generated.
- **Frame Timer** - Allows you to access the **Frame Timer** menu to manually control the frame timer:

**Period** - Allows you to set the period of the frame clock. The range is 1.000 to 559.0 ms. Finest resolution is 1 ns.

**Offset** - Allows you to set the frame clock offset from the sync source. The range is 0 to 10 s. Finest resolution is 10 ns.

**Reset Offset Display** - Allows you to reset the frame clock offset to 0 s.

**Sync Source** - Allows you to select the source you will use to align the Frame Timer. You may select **Off** (no sync source), **Ext Front** (external front), or **Ext Rear** (external rear).

<b>Trigger Default Settings</b>	
<b>RF burst:</b>	
Delay	0.000 sec
Peak level	-25.0 dB
Slope	Pos
<b>Video:</b>	
Delay	0.000 s
Level	-20.00 dBm
Slope	Pos
<b>Ext Front &amp; Ext Rear:</b>	
Delay	0.000 s
Level	2.00 V
Slope	Pos

<b>Trigger Default Settings</b>	
Trigger holdoff	20.00 ms
Auto trigger	100.0 ms, Off
<b>Frame timer:</b>	
Period	90.0 ms
Offset	0.00 s
Sync Source	Off

## Changing the Frequency Channel

After selecting the desired mode setup, you will need to select the desired center frequency. Press the **Frequency Channel** key to access the following menu:

- **Center Freq** - Enter a frequency value that corresponds to the desired RF channel to be measured. This is the current instrument center frequency for any measurement function.

When the iDEN or WiDEN mode is selected, the instrument will default to the following setting.

<b>Frequency Channel Default Settings</b>	
Center Frequency	806 MHz

---

## Installing Optional Measurement Personalities

When you install a measurement personality, you need to follow a three step process:

1. Determine whether your memory capacity is sufficient to contain all the options you want to load. If not, decide which options you want to install now, and consider upgrading your memory. Details follow in “[Do You Have Enough Memory to Load All Your Personality Options?](#)” on page 32.
2. Install the measurement personality firmware into the instrument memory. Details follow in “[Loading an Optional Measurement Personality](#)” on page 35.
3. Enter a license key number that activates the measurement personality. Details follow in “[Obtaining and Installing a License Key](#)” on page 35.

Adding measurement personalities requires the purchase of a retrofit kit for the desired option. The retrofit kit contains the measurement personality firmware and an entitlement certificate that is used to generate a license key from the internet website. A separate license key is required for each option on a specific instrument serial number and host ID.

For the latest information on Agilent Spectrum Analyzer options and upgrade kits, visit the following Internet URL:

[http://www.agilent.com/find/sa\\_upgrades](http://www.agilent.com/find/sa_upgrades)

### Do You Have Enough Memory to Load All Your Personality Options?

If you want to operate the instrument with four or less personality options installed, you can skip ahead to the next section, “[Loading an Optional Measurement Personality](#)” on page 35. If, after installing your options, you get error messages relating to memory issues, you can return to this section to learn more about how to optimize your configuration.

If you want to install your 5th or 6th option, you should check to see how much memory you have installed.

---

**NOTE**

When you install a firmware package, the installation program will tell you if you have enough memory to install the options you select.

If you have 64 MBytes of memory installed in your instrument, you should have ample memory to install six optional personalities, with



plenty of memory to spare for data and states.

If you have less than 64 MBytes of installed memory, depending how much data you save, you are unlikely to have any memory issues until you want to install your 4th or 5th option. If this is the case, you can either swap the applications in/out of memory as needed, or you can upgrade your hardware to 64 MBytes of memory.

To see the size of your installed memory for E4406A Transmitter Testers:

1. Press the **System** key, **MORE (1 of 3)**, and **MORE (2 of 3)** keys.
2. Read the **File System Key** - The total of the entries for **Used** and **Free** memory will total the installed flash memory, either 48 or 64 MBytes.

If you have 48 MBytes of memory, and you want to install more than 3 optional personalities, you may need to manage your memory resources. The following section, “[How to Predict Your Memory Requirements](#)” on page 33, will help you decide how to configure your installed options to provide optimal operation.

## How to Predict Your Memory Requirements

If you plan to install many optional personalities, you should review your memory requirements, so you can determine whether you have enough memory. There is an Agilent “Memory Calculator” available online that can help you do this, or you can make a calculated approximation using the information that follows. You will need to know your instrument’s installed memory size as determined in the previous section and then select your desired applications.

For E4406A see: [http://www.agilent.com/find/vsa\\_firmware](http://www.agilent.com/find/vsa_firmware)

Select the “Memory Calculator” link. You can try any combination of available personalities to see if you desired configuration is compatible with your installed memory.

When you install a firmware package, the installation program will also tell you if you have enough memory to install the options you select.

You can manually estimate your total memory requirements by adding up the memory allocations described in the following steps. The compare the desired total with the available memory that you identified in the previous section.

1. Program memory - Select option requirements from the table “[Measurement Personality Options and Memory Required](#)” on page 34.
2. Screens - .gif files need 20-25 kB each
3. State memory - State file sizes range from 21 KB for SA mode to 40

KB for W-CDMA. The state of every mode accessed since power-on will be saved in the state file. File sizes can exceed 150 KB each when several modes are accessed, for each state file saved.

**TIP** State memory retains settings for all states accessed before the **Save State** command. To reduce this usage to a minimum, reduce the modes accessed before the **Save State** is executed. You can set the PSA to boot into a selected mode by assessing the desired mode, then pressing the **System, Power On/Presets, Power On** keys and toggle the setting to **Last**.

### Measurement Personality Options and Memory Required

Personality Options <sup>a</sup> (for E4406A Transmitter Tester)	Option	File Size (E4406A Rev: A.08)
cdmaOne measurement personality	<b>BAC</b>	2.00 Mbytes <sup>b</sup>
NADC and PDC measurement personalities (not available separately)	<b>BAE</b>	2.50 Mbytes <sup>b</sup>
W-CDMA or W-CDMA w/ HSDPA measurement personality	<b>BAF, 210</b>	5.25 Mbytes <sup>b</sup>
cdma2000 or cdma2000 w/ 1xEV-DV measurement personality	<b>B78, 214</b>	4.14 Mbytes <sup>b</sup>
1xEV-DO measurement personality	<b>204</b>	4.95 Mbytes <sup>b</sup>
GSM (with EDGE) measurement personality	<b>202</b>	3.42 Mbytes <sup>b</sup>
Shared measurement library <sup>b</sup>	n/a	5.68 Mbytes
GSM measurement personality	<b>BAH</b>	3.42 Mbytes <sup>b</sup>
EDGE (with GSM) measurement personality	<b>202</b>	3.42 Mbytes <sup>b</sup>
EDGE upgrade from BAH measurement personality	<b>252</b>	3.42 Mbytes <sup>b</sup>
iDEN measurement personality	<b>HN1</b>	1.80 Mbytes <sup>b</sup>
Baseband I/Q Inputs	<b>B7C</b>	n/a (hardware only)

- a. Available as of the print date of this guide.  
b. Many VSA E4406A personality options use a 5.68 MByte shared measurement library. If you are loading multiple personalities that use this library, you only need to add this memory allocation once.

### Memory Upgrade Kits

The VSA 64 MByte Memory Upgrade kit p/n is E4406AU Option ANE.

For more information about memory upgrade kits contact your local sales/service office, or see:

<http://www.agilent.com/find/saupgrades>

## Loading an Optional Measurement Personality

You must use a PC to load the desired personality option into the instrument memory. Loading can be done from a firmware CD-ROM or an internet location. An automatic loading program comes with the files and runs from your PC.

You can check the Agilent internet website for the latest firmware versions available for downloading:

For VSA, see [http://www.agilent.com/find/vsa\\_firmware](http://www.agilent.com/find/vsa_firmware)

---

### NOTE

When you add a new option, or update an existing option, you will get the updated versions of all your current options as they are all reloaded simultaneously. This process may also require you to update the instrument core firmware so that it is compatible with the new option.

Depending on your installed hardware memory, you may not be able to fit all of the available measurement personalities in instrument memory at the same time. You may need to delete an existing option file from memory and load the one you want. Use the automatic update program that is provided with the files. Refer to the table showing “[Measurement Personality Options and Memory Required](#)” on page 34.

The approximate memory requirements for the options are listed above. These numbers are worst case examples. Some options share components and libraries, therefore the total memory usage of multiple options may not be exactly equal to the combined total.

## Obtaining and Installing a License Key

If you purchase an optional personality that requires installation, you will receive an “Entitlement Certificate” which may be redeemed for a license key specific to one instrument. Follow the instructions that accompany the certificate to obtain your license key.

To install a license key number for the selected personality option, use the following procedure:

---

### NOTE

You can also use this procedure to reinstall a license key number that has been deleted during an uninstall process, or lost due to a memory failure.

For E4406A:

1. Press **System, More, More, Install, Choose Option** to access the alpha

editor. Use this alpha editor to enter letters (upper-case), and the front-panel numeric keys to enter numbers for the option designation. You will validate your option entry in the active function area of the display. Then, press the **Done** key.

---

**NOTE**

Before you enter the license key for the EDGE Retrofit Option 252, you must already have entered the license key for the GSM Option BAH.

2. Press **License Key** to enter the letters and digits of your license key. You will validate your license key entry in the active function area of the display. Then, press the **Done** key.
3. Press the **Install Now** key. The message “New option keys become active after reboot.” will appear, along with the **Yes/No** menu: press the **Yes** key and cycle the instrument power off and then on to complete your installation process, or press the **No** key to cancel the installation process.

## Viewing a License Key

Measurement personalities purchased with your instrument have been installed and activated at the factory before shipment. The instrument requires a **License Key** unique to every measurement personality purchased. The license key number is a hexadecimal number specific to your measurement personality, instrument serial number and host ID. It enables you to install, or reactivate that particular personality.

Use the following procedure to display the license key number unique to your personality option that is already installed in your instrument:

For E4406A:

Press **System, More, More, Install, Choose Option** to enter the letters/numbers for the option you want. You can see the key on the **License Key** key. Press the **Done** key.

---

**NOTE**

*You will want to keep a copy of your license key number in a secure location. Press **System, More, then Show System** for E4406A, and print out a copy of the display that shows the license numbers. If you should lose your license key number, call your nearest Agilent Technologies service or sales office for assistance.*

## Using the Uninstall Key on E4406A

This key will make the option unavailable for use, but will not delete it from memory. The message “Application Not Licensed” will appear in the Status/Info bar at the bottom of the display. Record the 12-digit license key number for the option before you delete it. If you want to use that measurement personality later, you will need the license key number to reactivate the personality firmware.

**NOTE**

Using the **Uninstall** key does not remove the personality firmware from the instrument memory, and does not free memory to be available to install another option. If you need to free memory to install another option, refer to the instructions for loading firmware updates available at the URL: <http://www.agilent.com/find/vsa/>

1. Press **System, More (1 of 3), More (2 of 3), Uninstall, Choose Option** to access the alpha editor. Use this alpha editor to enter the letters (upper-case), and the front-panel numeric keys to enter the numbers (if required) for the installed option. You will validate your option entry in the active function area of the display. Then, press the **Done** key.
2. Pressing the **Uninstall Now** key will activate the **Yes/No** menu: press the **Yes** key to continue your uninstall process, or press the **No** key to cancel the uninstall process.
3. Cycle the instrument power off and then on to complete the uninstall process.

### Ordering Optional Measurement Personalities

When you order you personality option, you will receive an entitlement certificate. Then you will need to go to the web site to redeem your license by giving the instrument serial number, and host ID, and Entitlement certificate number.

Required Information:	Front Panel Key Path:
Model #: (Ex. E4406A)	
Host ID: _____	<b>System, Show System</b>
Instrument Serial Number: _____	<b>System, Show System</b>

Setting Up the iDEN or WiDEN Mode  
**Installing Optional Measurement Personalities**

---

### **3 Making iDEN or WiDEN Measurements**

---

## iDEN or WiDEN Measurements

Once you've selected the iDEN or WiDEN mode, the following measurements are available by pressing the **Measure** key.

- Adjacent Channel Power (ACP) [iDEN or WiDEN] – page 45
- Bit Error Rate (BER) [iDEN or WiDEN] – page 52
- MotoTalk Average Power (MT Avg Pwr) [iDEN] – page 68
- MotoTalk Transient EVM (MT Trans EVM) [iDEN] – page 74
- Occupied Bandwidth (OBW) [iDEN or WiDEN] – page 58
- Power Versus Time Measurement (PVT) [iDEN or WiDEN] – page 62
- Spectrum (frequency domain) Measurements [iDEN or WiDEN] – page 79
- Waveform (time domain) Measurements [iDEN or WiDEN] – page 87

This chapter includes information on:

- **Meas Control** keys in “[Measure Control](#)” on page 41
- **Meas Setup** keys to change parameters common to many iDEN measurements in “[Measurement Setup](#)” on page 42
- **ACP Meas Setup** keys in “[Making the Adjacent Channel Power Measurement](#)” on page 45
- **BER Meas Setup** keys in “[Making the Bit Error Rate Measurement](#)” on page 52
- **MT Avg Pwr Meas Setup** keys in “[Making the MotoTalk Average Power \(MT Avg Pwr\) Measurement](#)” on page 68
- **MT Trans EVM Meas Setup** keys in “[Making the MotoTalk Transient EVM \(MT Trans EVM\) Measurement](#)” on page 74
- **PVT Meas Setup** keys in “[Making the Power Versus Time Measurement](#)” on page 62
- **OBW Meas Setup** keys in “[Making the Occupied Bandwidth Measurement](#)” on page 58
- **Spectrum Meas Setup** keys in “[Making the Spectrum \(Frequency Domain\) Measurement](#)” on page 79
- **Waveform Meas Setup** keys in “[Making the Waveform \(Time Domain\) Measurement](#)” on page 87

These are referred to as one-button measurements. When you press the key to select the measurement it will become the active measurement, using settings and a display unique to that measurement. Data acquisitions will automatically begin provided trigger requirements, if any, are met.



## Preparing for Measurements

If you want to set the iDEN mode to a known, factory default state, press **Preset**. This will preset the mode setup and all of the measurements to the factory default parameters.

**NOTE**

Pressing the **Preset** key does not change the instrument mode.

To preset only the settings that are specific to the selected measurement, press **Meas Setup, More, Restore Meas Defaults**. This will set the measure setup parameters, for the currently selected measurement only, to the factory defaults.

### Initial Setup

Before making a measurement, make sure the mode setup and frequency/channel parameters are set to the desired settings. Refer to “[Changing the Mode Setup](#)” on page 26 and “[Changing the Frequency Channel](#)” on page 31.

### How to Make a Measurement

Follow the three-step process shown in the table below:

Step	Primary Key	Setup Keys	Related Keys
1. Select mode & setup mode	<b>Mode</b>	<b>Mode Setup, Input, Frequency Channel</b>	<b>System</b>
2. Select measurement & setup measurement	<b>Measure</b>	<b>Meas Setup</b>	<b>Meas Control, Restart</b>
3. Select view & setup view	<b>View/Trace</b>	<b>Span X Scale, Amplitude Y Scale, Next Window, Zoom</b>	<b>File, Save, Print, Print Setup, Marker, Search</b>

### Measure Control

The **Meas Control** front panel key controls processes that affect the running of the current measurement.

- **Measure** menu key. Press **Meas Control, Measure** (not to be confused with the front panel **Measure** key which has a different function) to toggle between Single and Cont (for continuous) measurement states. When set to Single, the measurement will continue until it has reached the specified number of averages set by the average counter. When set to Continuous, the measurement will run

## Making iDEN or WiDEN Measurements

### Preparing for Measurements

continuously, and perform averaging according to the current average type (repeat or exponential). The default setting is continuous.

- **Pause** key. Press **Meas Control, Pause** to pause the current measurement. Once toggled, the label of the **Pause** key changes to read **Resume**. The **Resume** key, once pressed, continues the active measurement from the point at which it was paused.
- **Restart** key. The **Restart** front panel key repeats the current measurement from the beginning, while retaining the current measurement settings.

## Measurement Setup

The **Meas Setup** key accesses features that enable you to adjust parameters of the current measurement, such as resolution bandwidth. You will also use the **Meas Setup** menu to access the **Meas Type, Trig Source, Offs & Limits**, and **Advanced** measurement setup features.

The following measure setup features can be used with some or all measurements.

- **Res BW** key. Press **Meas Setup, Res BW** to change the resolution of a given measurement. Selection of a narrower bandwidth will result in a longer data acquisition time.
- **% Power** key. Press **Meas Setup, % Power** to choose the percentage of the total channel power that you want to measure. The bandwidth of that amount of power will be measured. This selection is only for occupied bandwidth measurements.
- **Frames (iDEN)** key. Press **Meas Setup, Frames** to choose the number of frames that you want to measure bit error rate for. This selection is only for bit error rate measurements.
- **Slots (WiDEN)** key. Press **Meas Setup, Slots** to choose the number of slots that you want to measure bit error rate for. This selection is only for bit error rate measurements.
- **Meas Type** key. Press **Meas Setup, Meas Type** to choose to measure the total power or the power spectral density. This selection is only for adjacent channel power measurements.
- **Limit Test** key. Press **Meas Setup, Limit Test** to turn limit testing on and off. The limits that you want to test against can be selected.
- **Restore Meas Defaults** key. To preset only the settings that are specific to the selected measurement, press **Meas Setup, More, Restore Meas Defaults**. This will set the measure setup parameters, for the currently selected measurement only, to the factory defaults.

## Averaging

Selecting one of the averaging keys in the **Meas Setup** menu will allow you to modify the number, averaging mode, and type of averaging you use for the currently selected measurement.

- **Avg Number** - will allow you to change the number of N averages to be used when making the measurement.
- **Avg Mode Exp Repeat** - will allow you to choose either exponential or repeat averaging. This selection only effects the averaging after the number of N averages is reached (set using the **Avg Number** key).
  - **Single measurements:** Normal (linear) averaging is always used until the specified number of N averages is reached. When **Measure** is set at **Single**, data acquisitions are stopped when the number of averages is reached for a single measurement. Thus **Avg Mode** has no effect on single measurements.
  - **Exponential averaging:** When **Measure** is set at **Cont**, data acquisitions will continue indefinitely. After N averages, exponential averaging is used with a weighting factor of N (the displayed average count stops at N). Exponential averaging weights new data more than old data, which allows tracking of slow-changing signals. The weighting factor N is set using the **Averages**, **Avg Bursts**, or **Avg Number** key.
  - **Repeat averaging:** When **Measure** is set at **Cont**, data acquisitions will continue indefinitely. After N averages is reached, all previous result data is cleared and the average count is set back to 1. This is equivalent to being in **Measure Single** and pressing the **Restart** key each time the Single measurement finishes.

## Trig Source

Changing the selection in the **Trig Source** menu alters the trigger source for the selected measurement only. Not all of the selections are available for all measurements. Note that the **RF Burst (Wideband)**, **Video (IF Envlp)**, **Ext Front**, and **Ext Rear** menu keys found in the **Trigger** menu enable you to change settings to modify the delay, level, and slope for each of these trigger sources. Choose one of the following trigger sources:

- **Free Run (Immediate)** - the trigger occurs at the time the data is requested, completely asynchronous to the RF or IF signal.
- **RF Burst (Wideband)** - an internal wideband RF burst trigger that has an automatic level control for burst signals. It triggers on a level that is relative to the peak of the signal passed by the RF (12 MHz bandwidth).

## Making iDEN or WiDEN Measurements

### Preparing for Measurements

- **Video (IF Envlp)** - an internal IF envelope trigger. It triggers on an absolute threshold level of the signal passed by the IF.
- **Ext Front** - activates the front panel external trigger input (**EXT TRIGGER INPUT**). The external trigger must be a signal between  $-5$  and  $+5$  volts.
- **Ext Rear** - activates the rear panel external trigger input (**TRIGGER IN**). The external trigger must be a signal between  $-5$  and  $+5$  volts.
- **Frame** - uses the internal frame clock to generate a trigger signal. The clock parameters are controlled under the **Mode Setup** key or the measurement firmware, not both. See the specific measurement for details.
- **Line** - activates an internal line trigger. Sweep triggers occur at intervals synchronized to the line frequency.

Rear panel **TRIGGER 1 OUT** and **TRIGGER 2 OUT** connectors are coupled to the selected trigger source. These trigger outputs are always on the rising edge with a pulse width of at least  $1 \mu\text{s}$ .

---

## Making the Adjacent Channel Power Measurement

### Mode Availability

This measurement is available in the iDEN and WiDEN mode.

### Purpose

To maintain a quality call by avoiding channel interference, it is quite important to measure and reduce an adjacent channel leakage power transmitted from a mobile phone. The characteristics of adjacent channel leakage power are mainly determined by the transmitter design, particularly the low-pass filter.

Adjacent channel leakage power is defined by the iDEN standard as the total power within the bandwidth of  $\pm 10$  kHz, centered at 25 kHz offset from the carrier frequency.

### Measurement Method

This measurement analyzes the total power levels within the defined bandwidth of  $\pm 10$  kHz at given frequency offsets on both sides of the carrier frequency using Fast Fourier Transform (FFT).

The total peak power is measured, using a resolution bandwidth (automatically set) much narrower than the channel bandwidth, through the entire iDEN bandwidth of 18 kHz. Both the absolute power levels and the power levels relative to the center power band are displayed.

The measurement functions, such as averaging, trigger source, limit test, offsets and limits, need to be set up to make a measurement and establish pass/fail testing.

The PvT results are based on the slot power envelope relative to a power mask. During the slot off time the mask is the higher power of  $-54$  dBm or  $-60$  dBc. (Where dBc is power relative to the composite carrier power.) When the composite carrier power is above 6 dBm the relative limit for slot off time will be used, otherwise the absolute limit will be used.

When the absolute limit is used it is important take care with these two aspects of the measurement:

1. Minimize the amount of external attenuation between the radio and the instrument. This will improve the dynamic range of the measurement. For the best possible dynamic range change the instrument's **RF Input Range** setting to **Man** and then manually range

## Making iDEN or WiDEN Measurements

### Making the Adjacent Channel Power Measurement

the instrument using the **Input Atten** setting. Both of these menu keys are under the **Input** key.

2. Make sure that the instrument **External RF Attenuation** (under the **Input** key) is set to the actual amount of external attenuation used. This ensures that the power mask is set properly in the slot off time.

---

#### NOTE

The composite carrier power is below 6 dBm when the radio power cutback is greater than approximately 14 dB.

---

## Making the Measurement

---

#### NOTE

The factory default settings provide an iDEN compliant measurement. For special requirements, you may need to change some of the settings. Press **Meas Setup, More (1 of 2), Restore Meas Defaults** at any time to return all parameters for the current measurement to their default settings.

---

Select the desired center frequency as described in [“Changing the Frequency Channel” on page 31](#).

Press **Mode Setup, Radio, Inb Slot Format** to select the signal format. Except Full Slot Reserved, press **Color Code** to enter a number from 0 to 95 for the color code.

Press **Measure, ACPR** to immediately make an adjacent channel power measurement.

To change any of the measurement parameters from the factory default values, refer to the [“Changing the Measurement Setup”](#) section for this measurement.

## Results

The next figure shows an example result of adjacent channel power measurements in the bar graph window. The power levels at both sides of the carrier frequency are displayed in the graphic window and text window.

Figure 3-1

**iDEN Adjacent Channel Power Measurement Result**

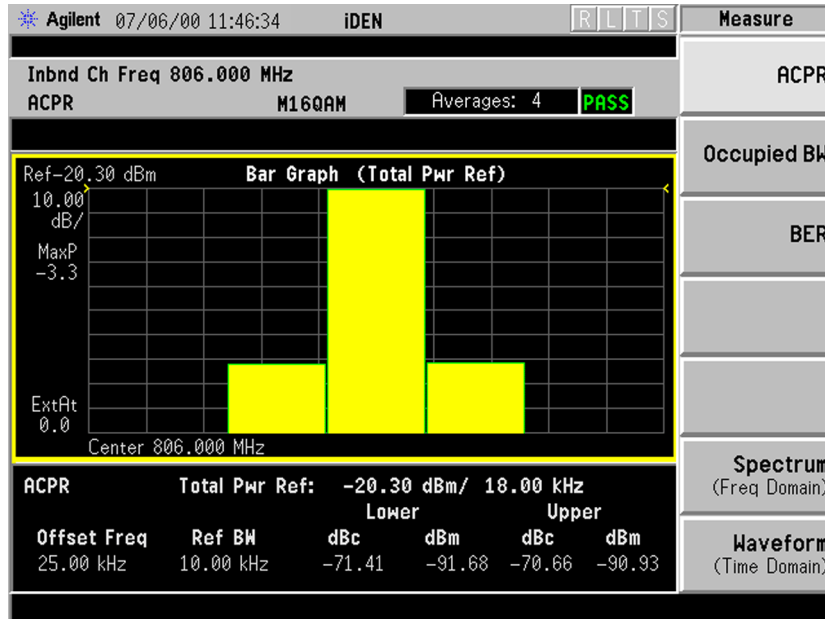


Figure 3-2

**WiDEN Adjacent Channel Power Measurement Result - All Carrier Configurations Except 50 kHz Outer**

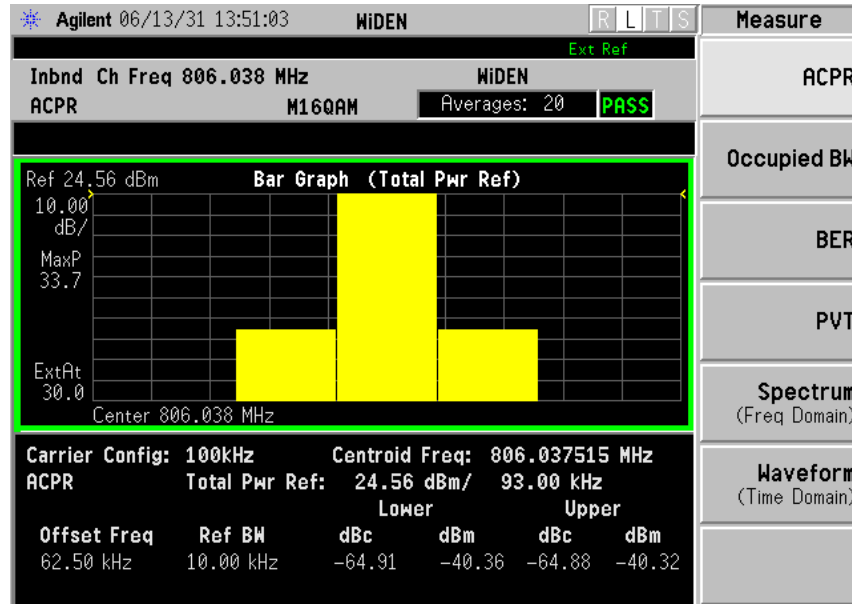
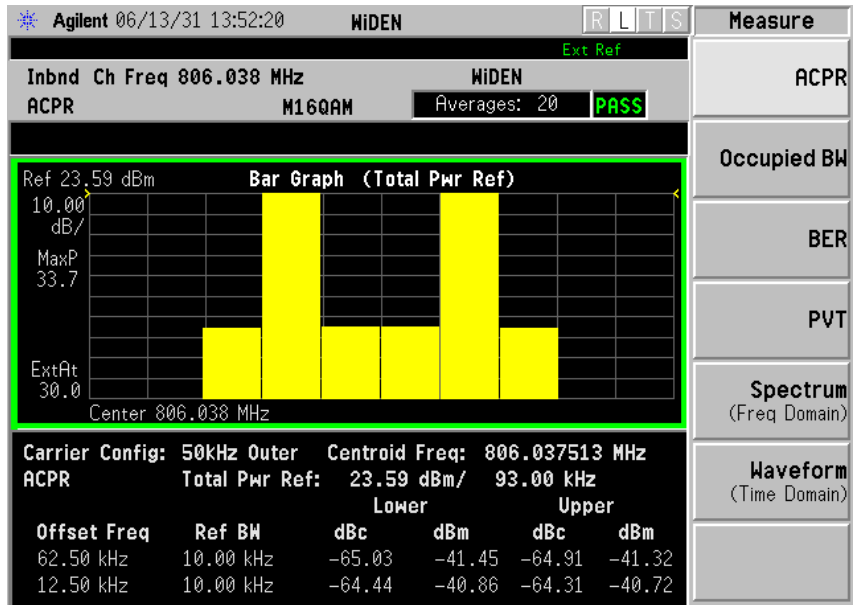


Figure 3-3

**WiDEN Adjacent Channel Power Measurement Result - Carrier**

Making iDEN or WiDEN Measurements  
 Making the Adjacent Channel Power Measurement

**Configuration of 50 kHz Outer**



**Changing the Measurement Setup**

The next table shows the factory default settings for adjacent channel power measurements.



Table 3-1

Adjacent Channel Power Measurement Defaults

Measurement Parameter	Factory Default Condition	
	iDEN	WiDEN
Average number	20, On	20, On
Average mode	Exponential	Exponential
Trigger source	RF burst (inbound)	RF burst (inbound)
Limit Test	On	On
Reference BW	18 kHz	Dependent on the carrier configuration
Offset frequency	25.000 kHz	Dependent on the carrier configuration
Offset bandwidth	10.000 kHz	18.000 kHz
Absolute limit	0.00 dBm	0.00 dBm
Fail (iDEN) / Composite Fail (WiDEN)	Relative	Relative
Relative limit (carrier)	-60 dBc	-50 dBc
Relative limit (PSD)	-57.45 dB	N/A

Make sure the adjacent channel power measurement is selected under the **Measure** menu. The **Meas Setup** key accesses the menu which allows you to modify the average number, average mode and trigger source for this measurement as described in “[Measurement Setup](#)” on page 42. However, the trigger source does not include **Video** or **Line**. In addition, the following parameters for adjacent channel power measurements can be modified:

- **Limit Test** - Allows you to toggle the limit test function between **On** and **Off**. If set to **On**, **Abs Lim** and/or **Rel Lim** need to be specified to execute pass/fail tests with the logical judgement under the **Fail** key (iDEN) or **Comp Fail** key (WiDEN). Pass/fail results are shown in the active display window with the number of averages. In the text window, a red character F is shown on the right side of each measurement result, either relative or absolute, if it exceeds the limits with its logical judgement.
- **Ref BW** - Allows you to enter a reference bandwidth ranging from 1.00 kHz to 5.00000 MHz with the best resolution of 1 Hz. When this parameter is changed, the **Total Pwr Ref** in the summary data window changes to that value.
- **Offs & Limits** - Allows you to access the menu to change the following parameters for pass/fail tests:

## Making iDEN or WiDEN Measurements

### Making the Adjacent Channel Power Measurement

**Offset Freq** - Allows you to store a frequency offset value. For iDEN the offset for the measurement is specified as 25 kHz. The offset selection is shown on the key label.

**Offset BW** - Allows you to select bandwidth of the carrier and offset channels that you want to measure.

**Abs Limit** - Allows you to enter an absolute limit value ranging from -200.00 to +50.00 dBm with 0.01 dB finest resolution.

**Fail** - Allows you to access the following menu to select one of the logic keys for fail conditions between the measurement results and the test limits:

**AND** - Fail is shown if one of the relative ACP measurement results is larger than **Rel Lim** AND the absolute ACP measurement result is larger than **Abs Limit**.

**OR** - Fail is shown if one of the relative ACP measurement results is larger than **Rel Lim** OR one of the absolute ACP measurement results is larger than **Abs Limit**.

**Absolute** - Fail is shown if one of the absolute ACP measurement results is larger than **Abs Limit**.

**Relative** - Fail is shown if one of the relative ACP measurement results is larger than **Rel Lim**.

**Rel Lim (Car)** - Allows you to enter a limit value, relative to the carrier, ranging from -150.00 to +50.00 dB with 0.01 dB finest resolution.

**Rel Lim (PSD)** - Allows you to enter a limit value, relative to the power spectral density, ranging from -150.00 to +50.00 dB with 0.01 dB finest resolution.

## Troubleshooting Hints

This adjacent channel power ratio measurement can reveal degraded or defective parts in the transmitter section of the UUT. The following examples are those areas to be checked further.

- Some faults in the DC power supply control of the transmitter power amplifier, RF power controller of the pre-power amplifier stage, or I/Q control of the baseband stage
- Some degradation in the gain and output power level of the amplifier due to the degraded gain control and/or increased distortion
- Some degradation of the amplifier linearity and other performance characteristics

Power amplifiers are one of the final stage elements of a base or mobile transmitter and are a critical part of meeting the important power and spectral efficiency specifications. Since ACP measures the spectral

response of the amplifier to a complex wideband signal, it is a key measurement linking amplifier linearity and other performance characteristics to the stringent system specifications.

---

## Making the Bit Error Rate Measurement

### Mode Availability

This measurement is available in the iDEN and WiDEN mode.

### Purpose

The BER test lets you test for bit errors in your iDEN or WiDEN signal. BER is ratio of number of bits failed by number of bits tested. Prepare to run the iDEN or WiDEN BER test by first reviewing the information in [Chapter 2, “Setting Up the iDEN or WiDEN Mode,”](#) on page 25.

### Measurement Method

The iDEN BER test takes data from the RF input and then performs analysis on that data to find bit errors. It measures BER on all four channels.

The WiDEN BER test takes data from the RF input and then performs analysis on that data to find errors per carrier which is consisted of by captured multiple-carrier signal. It measures BER on all subcarriers of all carriers. The BER test searches for the slot that contains data. When one slot is found, BER test searches if more active slots exists in captured signal. The timing of slots is estimated by timing of the slot found first.

The **Frames** or **Slots** menu key determines the number of 90 milli-second or 45 milli-second frames (iDEN) or 15 milli-second slots (WiDEN) (dependent on the signal format) that the BER test demodulates. Since each frame has multiple slots, the BER test searches for the slot that contains data. If the data in that slot matches one of the 16 transmission unit data words defined by iDEN, the BER test displays the number of the WORD that it found. If not, the slot is considered having 50% bit error. The number of frames that were actually found is indicated.

The peak and RMS EVMs of each sub-channel, as well as the composite RMS EVM of all channels, are calculated and can be obtained using SCPI remote commands.

This measurement can also perform PVT test. Results can be obtained using SCPI remote commands.

The PvT results are based on the slot power envelope relative to a power mask. During the slot off time the mask is the higher power of  $-54$  dBm or  $-60$  dBc. (Where dBc is power relative to the composite carrier power.) When the composite carrier power is above 6 dBm the relative limit for slot off time will be used, otherwise the absolute limit

will be used.

When the absolute limit is used it is important take care with these two aspects of the measurement:

1. Minimize the amount of external attenuation between the radio and the instrument. This will improve the dynamic range of the measurement. For the best possible dynamic range change the instrument's **RF Input Range** setting to **Man** and then manually range the instrument using the **Input Atten** setting. Both of these menu keys are under the **Input** key.
2. Make sure that the instrument **External RF Attenuation** (under the **Input** key) is set to the actual amount of external attenuation used. This ensures that the power mask is set properly in the slot off time.

---

**NOTE**

The composite carrier power is below 6 dBm when the radio power cutback is greater than approximately 14 dB.

---

## Making the Measurement

---

### NOTE

The factory default settings provide an iDEN compliant measurement. For special requirements, you may need to change some of the settings. Press **Meas Setup, More (1 of 2), Restore Meas Defaults** at any time to return all parameters for the current measurement to their default settings.

---

Press **Mode Setup, Radio, Inb Slot Format** to select the signal format. Except Full Slot Reserved, press **Color Code** to enter a number from 0 to 95 for the color code.

Press **Measure, BER** to immediately make a bit error rate measurement. The bit error rate will be measured on all four channels. To change any of the measurement parameters from the factory default values, refer to the **Meas Setup** key and the [“Changing the Measurement Setup”](#) section for this measurement.

## Results

By default, the iDEN BER test displays two traces. The BER test also displays the following results at the bottom of the display:

- Bit Error Rate, shown as a percentage total for all frames
- Current frame BER, shown as a percentage
- Residual BER, which is the Bit Error Rate not counting the dropped frames, shown as a percentage
- Bits tested, which is the number of bits tested
- Bits failed, which is the number of bits that failed
- Frames found
- Frames tested
- Frame Erasure Rate FER, shown as a percentage of frames dropped over frames tested
- Current identified word

By default, the WiDEN BER measurement displays a single tabular window. This window shows the following:

- Detected or selected carrier configuration
- Total Bit Error Rate of composite carriers, shown as a percentage
- Residual BER of composite carriers, which is the Bit Error Rate not counting the dropped slots, shown as a percentage
- Slot Erasure Ratio (SER), shown as a percentage
- Bits tested, which is the number of bits tested

- Bits failed, which is the number of bits that failed
- Slots found
- Slots tested
- BER, Res BER, and SER of each carrier, shown as percentages
- Rel Pwr of each carrier, where the power of each carrier relative to the composite burst power is shown in dB and can be obtained by using the SCPI command: MEASure|READ|FETCh:BER10?

**The BER test computes the bit error rate as follows:**

**Equation 3-1 Bit Error Rate Calculation**

$$\text{BER (\%)} = \frac{\text{Number of bits failed}}{\text{Number of bits tested}} \times 100\%$$

The results, from all frames that were tested, are shown. It also shows the number of frames successfully demodulated and the number of frames tested.

The BER test changes the results as follows if it cannot demodulate a frame (or when a frame is dropped):

*Bits Failed* is increased by half the number of data bits in the frame (not including the sync or pilot symbols). Statistically, a pure noise signal should have a BER of 50%. *Bits Tested* is increased by the number of data bits in the frame. *Found*, shows two numbers: the first number shows the number of frames successfully demodulated; the second number shows the number of frames tested. For example, *Found: 4/15 frames* means 15 frames were tested. Of these frames, only 4 were successfully demodulated. The other 11 frames could not be found. The sync, word, or pulse were not found.

Residual BER only counts those frames that are found. In other words, when a frame can not be found, neither the number of bits failed nor the number of bits tested increase.

The results use some of the following terminology:

*Word* is the transmission data unit word that contained the symbol with the bit errors.

*Total* is the total number of bit errors in the composite symbol.

Figure 3-4

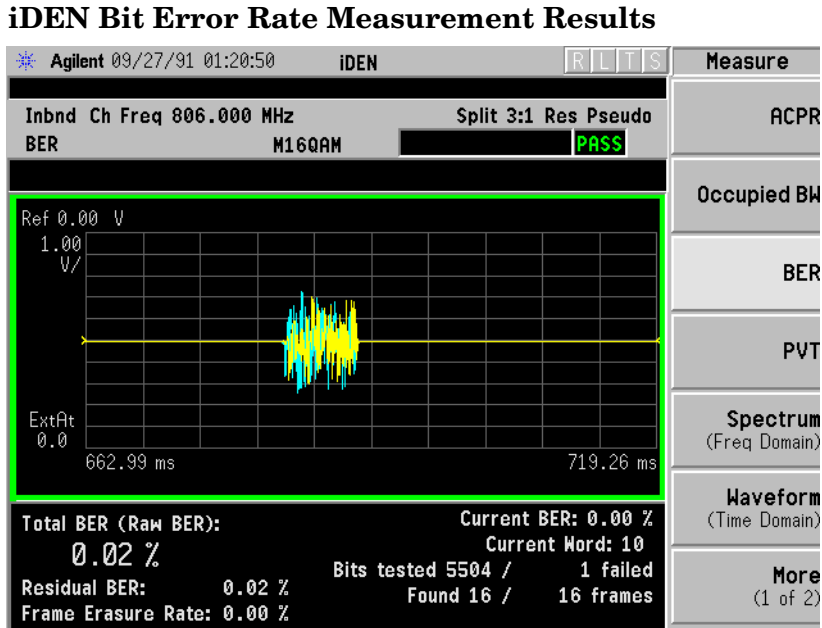
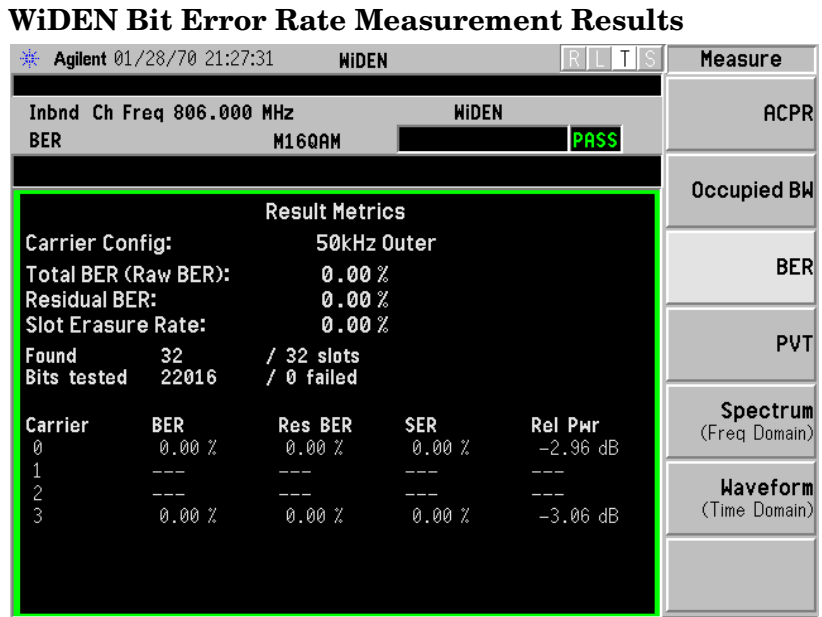


Figure 3-5



## Changing the Measurement Setup

**Frames** determines the number of frames used by each test. The default is 16.



**Table 3-2 Bit Error Rate Measurement Defaults**

Measurement Parameter	Factory Default Condition	
	iDEN	WiDEN
Frames (iDEN) / Slots (WiDEN)	16	16
Trigger source	Video (IF envelope)	Video (IF envelope)
Limit Test	On	On
Bit error rate	5%	5%
Res BW	19.531 kHz	Dependent on the carrier configuration

---

## Making the Occupied Bandwidth Measurement

### Mode Availability

This measurement is available in the iDEN and WiDEN mode.

### Purpose

To utilize the limited resource of radio frequency bands to provide as many communication channels as possible, it is critical to measure and control the occupied bandwidth transmitted from a mobile phone. This occupied bandwidth is defined as the frequency bandwidth in which 99% of the total power is measured.

The occupied bandwidth of a mobile phone tends to be improved if its adjacent channel power is reduced. To provide as many channels as possible to meet the increasing number of subscribers, both of these characteristics of a mobile phone need to be measured and analyzed for further performance improvement.

### Measurement Method

This is the frequency bandwidth in which 99% of the total power is measured, based on Fast Fourier Transform (FFT) theory.

In the actual measuring process, first the total channel power is measured using a sampling method. Then each power sample is integrated up to 0.5% of the total power from the lowest and highest frequency sides to determine the low and high limit frequencies. The difference derived from these frequencies is the occupied bandwidth.

The measurement functions such as averaging, trigger source, limit test and limit need to be set up to make a measurement and pass/fail test. The test results are displayed in the graphic window and in the text window.

### Making the Measurement

---

**NOTE**

The factory default settings provide an iDEN or WiDEN compliant measurement. For special requirements, you may need to change some of the settings. Press **Meas Setup, More (1 of 2), Restore Meas Defaults** at any time to return all parameters for the current measurement to their default settings.

Select the desired center frequency as described in [“Changing the Frequency Channel” on page 31](#).

Press **Mode Setup, Radio, Inb Slot Format** to select the signal format. Except Full Slot Reserved, press **Color Code** to enter a number from 0 to 95 for the color code.

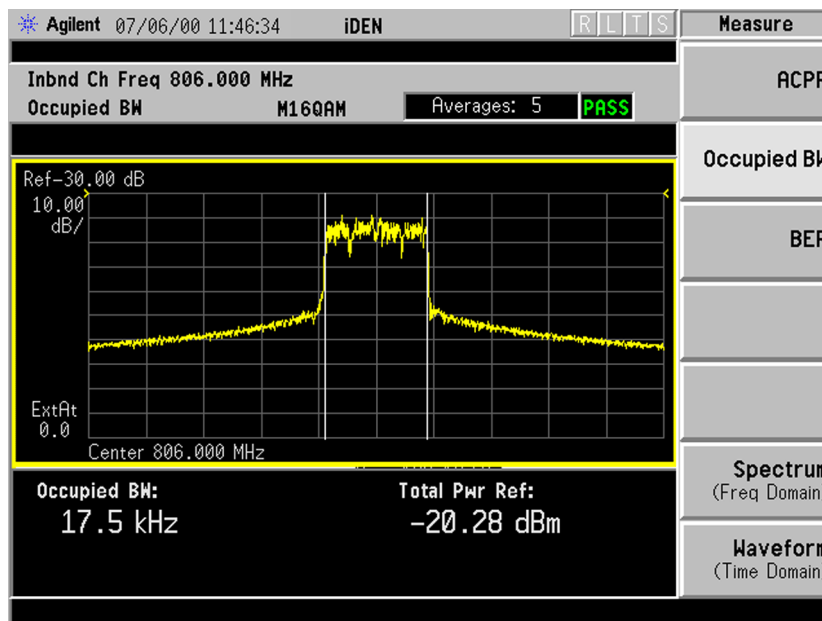
Press **Measure, Occupied BW** to immediately make the occupied bandwidth measurement. To change any of the measurement parameters from the factory default values, refer to the “[Changing the Measurement Setup](#)” section for this measurement.

## Results

For iDEN: in the upper window the sampled power distribution is displayed with 0.5% frequency marker lines. The actual measured data of the occupied bandwidth and the total channel power are shown in the lower window.

**Figure 3-6**

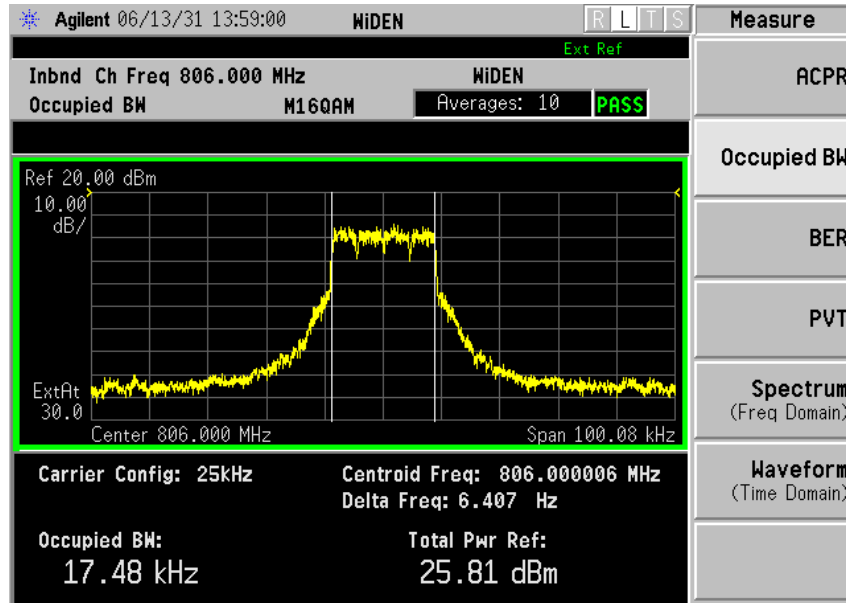
**iDEN Occupied Bandwidth Measurement Results**



For WiDEN: in the upper window, the sampled power distribution is displayed with two frequency marker lines. The frequency marker lines denotes the occupied power within a specified percentage (default 99%). The actual measured data of the occupied bandwidth, the total channel power, and the selected or detected carrier configuration are shown in the lower window.

Figure 3-7

**WiDEN Occupied Bandwidth Measurement Results**



**WiDEN Trace Display Notations and Numeric Data Table**

- **Center** - The “Center” frequency, shown in the lower left of the trace display, is the user-entered center frequency of the instrument. However, the trace is *not centered* on this user-entered center frequency; instead, the trace display is shown centered around the signal centroid (indicated in the data table section of the display).
- **Centroid Freq** - The “Centroid Freq”, shown in the data table section of the display, is the centroid of the signal and is the center of the trace display.
- **Delta Freq** - The “Delta Freq”, shown in the data table section of the display, is the difference between the signal centroid frequency and the user entered center frequency:  $F_{\Delta} = F_{\text{Centroid}} - F_{\text{user entered center}}$

**Changing the Measurement Setup**

The next table shows the factory default settings for occupied bandwidth measurements.

**Table 3-3 Occupied Bandwidth Measurement Defaults**

Measurement Parameter	Factory Default Condition	
	iDEN	WiDEN
Log Scale	10.00 dB/div	10.00 dB/div
Avg Number	10, On	10, On
Avg Mode	Exponential	Exponential
Trigger Source	Video (IF envelope)	Video (IF envelope)
% (percent) power	99%	99%
Limit Test	On	On
Limit	20.0 kHz	20.0 kHz

Make sure the occupied bandwidth measurement is selected under the **Measure** menu. The **Meas Setup** key accesses the menu which allows you to modify the averaging and trigger source for this measurement as described in “[Preparing for Measurements](#)” on page 41. In addition, the following occupied bandwidth measurement parameters can be modified:

- **Limit Test** - Allows you to toggle the limit test function between **On** and **Off**. If set to **On**, the **Limit** key needs to be pressed to specify the limit value. Pass/fail results are shown in the active display window with the number of averages.
- **Limit** - Allows you to specify the frequency limit value ranging of:

<b>iDEN</b>	10.000 to 60.000 kHz	0.1 kHz resolution.
<b>WiDEN</b>	10.000 to 200.000 kHz	0.1 kHz resolution.

---

## Making the Power Versus Time Measurement

### Mode Availability

This measurement is available in the iDEN and WiDEN mode.

### Purpose

In iDEN inbound, a preamble waveform, referred as AGC, is transmitted prior to the modulated symbols of the TDM slot. This AGC is used by the base receiver to estimate the power of the TDM slot, and to set AGC attenuation properly. To allow proper TDM slot AGC functionality at the base receiver, the preamble waveform needs to fit into a defined time domain characteristics. At the end of the TDM slot, to avoid causing interference to adjacent slot, the transmit power needs to drop below certain level within certain time interval.

### Measurement Method

The measurement acquires one burst of iDEN signal in time domain. The acquisition time is determined according to how many burst should be averaged. Demodulation is performed to find the synchronization and pilot symbols. And the start of transmission is defined as 80  $\mu$ s. The average power between the peak of the first modulated symbol ( $t_s$ ) and the peak of the last modulated symbol ( $t_e$ ) is computed and displayed. This average power is used as the Y reference for the time mask. The modulated symbols plus 10 symbols on each end are displayed with the time mask. A Pass/Fail annunciator indicates whether the burst fits into the time mask.

If average is turned on, the measurement captures consecutive **Avg Bursts** frames, and averages them. The RMS average of the average power (transmit power) of all bursts is used as the Y reference for the time mask,

Since the mobile may drift in frequency, the measurement does automatic carrier estimate before capturing data for demodulation. Press **Meas Setup, Carr Est Time** to enter a time interval between carrier estimate. To force carrier estimate every time, set the **Carr Est Time** to 0.0 second. If the phone does not drift in frequency, set the **Carr Est Time** to a large number to avoid performing carrier estimation. The measurement keeps a timer. Only when the timer expires will the measurement perform carrier estimation, and then the timer is reset. Use the **Carr Est Time** key to set the timer.

## Making the Measurement

---

### NOTE

The factory default settings provide a standard compliant measurement. For special requirements, you may need to change settings. Press **Meas Setup, More (1 of 2), Restore Meas Defaults** at any time to return all parameters for the current measurement to their default settings.

---

Press **Measure, PVT** to activate the power vs. time measurement.

Press **Frequency** to enter a numeric value for the center frequency.

Press **Mode Setup, Radio, Inb Slot Format** to select the signal format. Except Full Slot Reserved, press **Color Code** to enter a number from 0 to 95 for the color code.

There are four keys that are frequently used to change power vs. time measurement settings. These are the **Carr Est Time** and **Avg Bursts**, and the **Trig Source** and **Limit Test** keys located in the **Meas Setup** menu.

Press **Avg Bursts** to turn on/off average stat and enter average number.

Press **Meas Setup, Trig Source**. The trigger source determines how the analyzer acquires data. If **RF Burst** or **IF** is selected the rising edge of a burst will be used to initiate data acquisition. If **Ext Front** or **Ext Rear** is selected an external known reference in time will be provided for the data acquisition. In such cases, the external trigger is assumed to be near the beginning of the burst, otherwise, set the external trigger delay accordingly to bring the trigger at the rising edge of the burst.

Press **Meas Setup, More, Advanced, Limit Test** to turn on or off comparing the signal to its time mask. The time mask will be displayed regardless of the limit test state.

## Results

The views available under the **View/Trace** menu are **Burst** and **Rise & Fall**. See [“Changing the View” on page 67](#).

Information shown in the left margin of the displays include:

- **ExtAt** - This value reflects the **External RF Atten** setting.
- **Trig** - The **Trigger Source** setting used in the current measurement

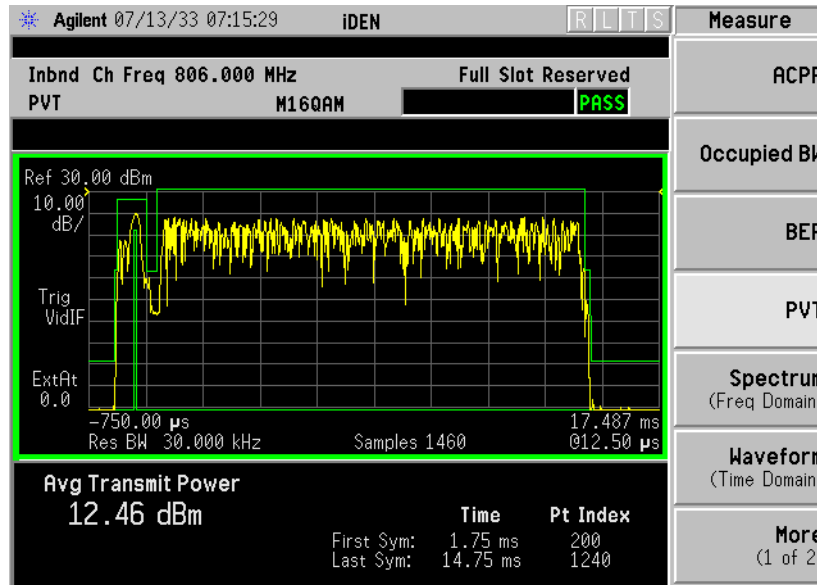
The **Current Data** displayed at the bottom of the Burst and Rise & Fall views include:

- **Current Transmit Pwr** (iDEN) - This is the average power between  $t_s$  and  $t_e$  of the current burst.
- **Curr Power (Composite)** (WiDEN) - This is the average power between  $t_s$  and  $t_e$  of the current burst for a composite of all carrier.

Making iDEN or WiDEN Measurements  
 Making the Power Versus Time Measurement

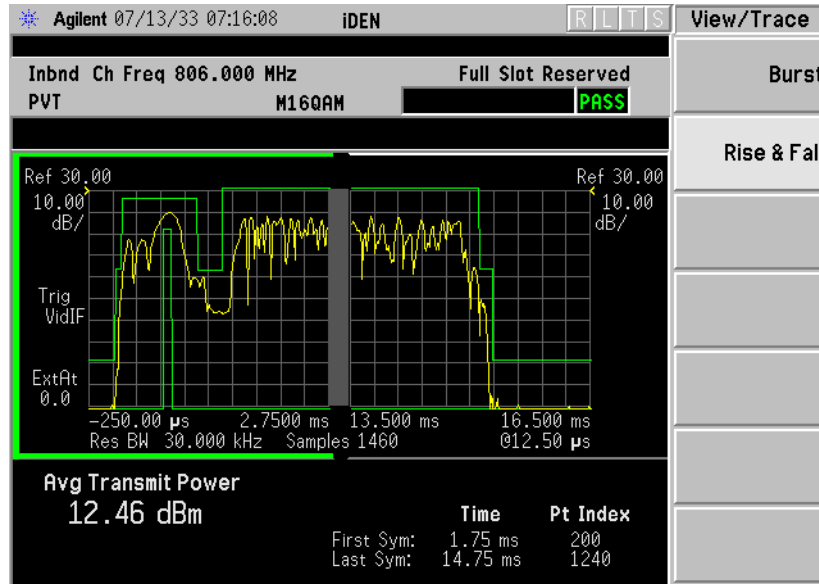
- **SGC Corr** - Scaling factor determined by the number of carriers and applied to the selected carrier signal power. (WiDEN only)
- - Scaling factor determined by the number of carriers and applied to the selected carrier signal power. (WiDEN only)
- **Avg Transmit Pwr** - This is the average of the transmit power of all bursts.
- **Time** (of first and last symbol) - This is the time of the first ( $t_s$ ) and last ( $t_e$ ) modulated symbol in the displayed trace.
- **Pt Index** (of first and last symbol) - This is the point index of the first and last modulated symbol in the displayed trace.

**Figure 3-8** iDEN Power vs. Time Result - Burst View

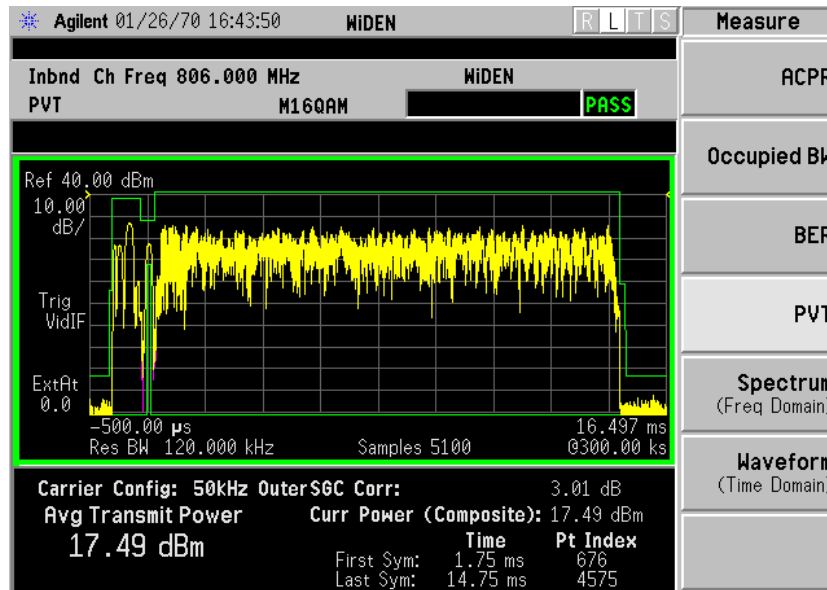




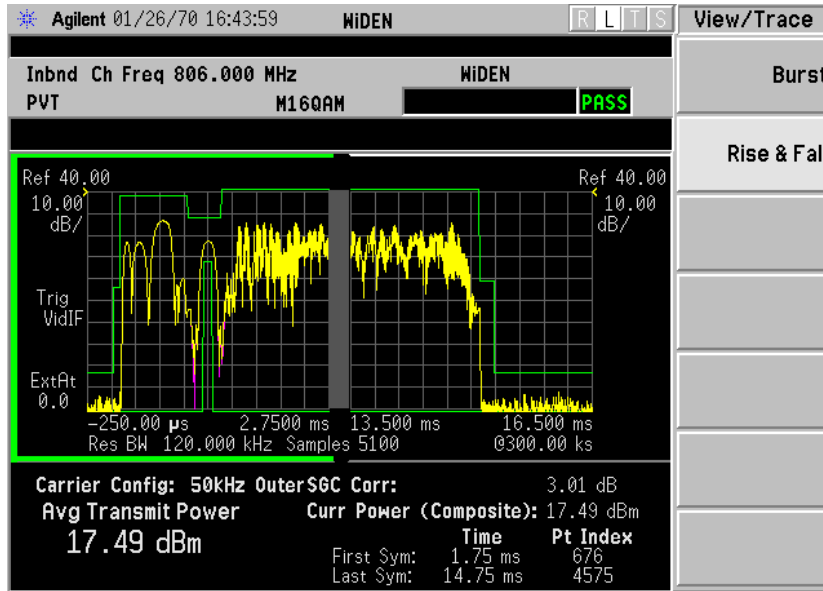
**Figure 3-9 iDEN Power vs. Time Result - Rise & Fall View**



**Figure 3-10 WiDEN Power vs. Time Result - Burst View**



**Figure 3-11 WiDEN Power vs. Time Result - Rise & Fall View**



**Changing the Measurement Setup**

**Table 3-4 Power vs. Time Measurement Defaults**

Measurement Parameter	Factory Default Condition	
	iDEN	WiDEN
Avg Bursts	16 and Off	16 and Off
Avg Type	Pwr Avg (RMS)	Pwr Avg (RMS)
Carrier Estimate Interval	10,000 s	10,000 s
Trig Source	Video (Envelope)	Video (Envelope)
Limit Test	On	On
Meas Carrier	N/A	All (Composite)
<b>Advanced</b>		
RBW Filter	Gaussian	Flat
Res BW	30.000 kHz	120.000 kHz

**NOTE** Parameters that are under the **Advanced** key seldom need to be changed. Any changes from the default values may result in invalid measurement data.

Make sure the Power vs. Time measurement is selected under the **Measure** menu. The **Meas Setup** key will access a menu which allows you to modify the trigger source and the limit test for this measurement (as

described in the “[Measurement Setup](#)” on page 42). In addition, the following power vs. time measurement parameters can be modified:

- **Carr Est Time** - This key allows you to set the time interval between carrier estimations. Values from 0.000000 sec through 200.000000 sec may be entered.
- **Advanced** - accesses a menu to change the following parameters:
  - RBW Filter** - chooses the type of filter, either **Gaussian** or **Flat** (Flatop). Gaussian is the best choice when looking at the overall burst or the rising and falling edges, as it has excellent pulse response. If you want to precisely examine just the useful part of the burst, choose **Flat**.
  - Res BW** - sets the resolution bandwidth (IF bandwidth).

### Power vs. Time Custom Masks

For the Power vs. Time measurement, you can define a user configurable limit mask to apply to the measured burst. Parameters set for the PvT measurement using this feature will also be applied to the BER measurement when the BER Limit Test is turned on. This feature can only be accessed via SCPI commands. Refer to the [Chapter 5, “iDEN Programming Commands,”](#) on page 101.

### Changing the View

The **View/Trace** key accesses a menu that allows you to select the desired view of the measurement from the following selections:

- **Burst** - views the entire burst of interest as determined by the current trigger source, burst sync, training sequence, and timeslot settings. To view a different burst of interest you must set these parameters for the selected timeslot. To view multiple slots use the **Multi-Slot** key described below. See [Figure 3-8 on page 64](#)
- **Rise & Fall** - zooms in on the rising and falling portions of the burst being tested. See [Figure 3-9 on page 65](#).

---

**NOTE**

The limit test will still be performed on the entire burst (viewed using the **Burst** menu) when **Rise & Fall** is selected.

---

### Troubleshooting Hints

If a transmitter fails the Power vs. Time measurement this usually indicates a problem with the units output amplifier or leveling loop.

---

## Making the MotoTalk Average Power (MT Avg Pwr) Measurement

### Mode Availability

This measurement is available in the iDEN mode.

### Purpose

MotoTalk Average Power is used to obtain the average transmit power of normal (traffic) bursts.

### Measurement Method

If the **Meas Method** is set to **Burst**, the measurement acquires **Avg Bursts** number of slots, search all the traffic burst in the captured data, compute the average power of each traffic burst. If the number of traffic bursts is less than the **Avg Bursts** (there might be preamble or sync bursts in the captured data), the measurement will acquire more data, and repeat the process until the total number of traffic bursts reaches the average count. The average, maximum, and minimum of the average burst power are also reported.

If the **Meas Method** is set to **Gated**, the measurement captures **Gated Time** number of slots, and computes the average power of the entire data record.

If the **Meas Method** is set to **Gated & Burst**, the measurement captures **Gated Time** number of slots, computes the average power of the entire data record, then finds all the traffic bursts in the captured data, computes average power of each traffic bursts. The average, maximum, and minimum of the average traffic burst power are also reported.

There are 3 types of bursts: preamble, sync, and traffic. There are 2 methods to identify them. If the **Burst ID Method** is set to **RF Amptd**, the measurement uses the amplitude variation within a burst and the burst position to identify the type of burst.

If the **Burst ID Method** is set to **Sync Word**, the measurement performs demodulation and use the sync word to identify the type of burst. The former is faster than the later. For both methods to work well, the **Res BW** should not be set to more than 35 kHz.

### Making the Measurement

---

**NOTE**

The factory default parameters provide a good starting point. You will likely want to change some of the settings. Press **Meas Setup**, **More**, **Restore Meas Defaults** at any time to return all parameters for the

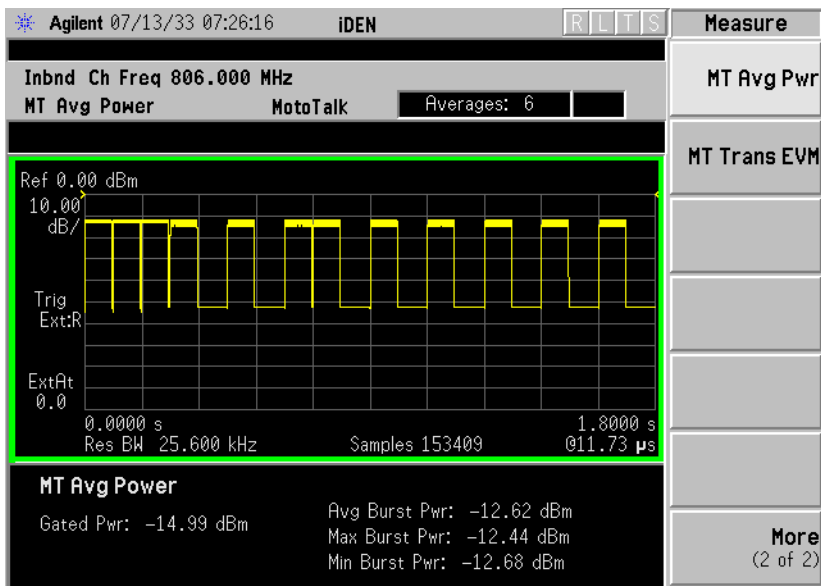
current measurement to their default settings.

Press **Measure, MT Avg Pwr** to immediately make MotoTalk Average Power the active measurement.

To change any of the measurement parameters from the factory default values, refer to the [“Changing the Measurement Setup”](#) section for this measurement.

### Results

**Figure 3-12** Average Power Measurement Results- RF Envelope Window



### Changing the Measurement Setup

**Table 3-5** MotoTalk Average Power Measurement Defaults

Measurement Parameter	Factory Default Condition
Average Bursts: Avg Number	20 On
Meas Method:	Burst
Gate Time (Sweep Time)	20 slots
Trigger Source	RF Burst
Burst ID Method	RF Amptd
<b>RF Envelope Window:</b> Amplitude Y Scale Scale/Div Reference	 10.00 dB 0.00 dBm (Top)

**Table 3-5 MotoTalk Average Power Measurement Defaults**

Measurement Parameter	Factory Default Condition
<b>Advanced</b>	
Res BW	25.600 kHz
RBW Filter	Gaussian
Decimation	0 Auto

**NOTE** Parameters that are under the **Advanced** key seldom need to be changed. Any changes from the default values may result in invalid measurement data.

Make sure the **MT Avg Pwr** measurement is selected under the **Measure** menu. Press the **Meas Setup** key to access a menu which allows you to modify the trigger source for this measurement (as described in “[Measurement Setup](#)” on page 42). In addition, the following parameters can be modified:

- **Meas Method** - This key allows you to choose the method use in making the measurement. You may set the method to Burst, Gated, or Gated and Burst.
  - **Burst**: When **Meas Method** is set to **Burst**, the measurement acquires **Avg Bursts** number of slots, search all the traffic burst in the captured data, compute the average power of each traffic burst. If the number of traffic bursts is less than the **Avg Bursts** (there might be preamble or sync bursts in the captured data), the measurement will acquire more data, and repeat the process until the total number of traffic bursts reaches the average count. The average, maximum, and minimum of the average burst power are also reported.
  - **Gated**: When **Meas Method** is set to **Gated**, the measurement captures **Gated Time** number of slots, and computes the average power of the entire data record.
  - **Gated & Burst**: When **Meas Method** is set to **Gated & Burst**, the measurement captures **Gated Time** number of slots, computes the average power of the entire data record, then finds all the traffic bursts in the captured data, computes average power of each traffic bursts. The average, maximum, and minimum of the average traffic burst power are also reported.
- **Avg Bursts** - This key allows you to set the burst averaging function on or off and set the number of N averages to be used when making the measurement. This parameter is effective when **Meas Method** is set to **Burst**.
- **Gated Time** - This key allows you to set the number of slots to capture. Values between 1 to 200 slots can be entered, depending

upon the resolution bandwidth setting. This parameter is effective when **Meas Method** is set to **Gated** or **Gated & Burst**

- **Burst ID Method** - This key allows you to choose one of two methods to identify the type of burst used. The three burst types are preamble, sync, and traffic. The identification methods are RF Amptd and Sync Word.
  - **RF Amptd**: When **Burst ID Method** is set to **RF Amptd**, the measurement uses the amplitude variation within a burst and the burst position to identify the type of burst.
  - **Sync Word**: When **Burst ID Method** is set to **Sync Word**, the measurement performs demodulation and use the sync word to identify the type of burst. The former is faster than the later. For both methods to work well, the **Res BW** should not be set to more than 35 kHz.
- **Advanced** menu key. This key accesses the features listed below.
  - RBW Filter** - This key toggles to select a flat top or a Gaussian resolution bandwidth filter. A Gaussian filter provides more even time domain response, particularly for bursts. A flat top filter provides a flatter bandwidth but is less accurate for pulse responses. A flat top filter also requires less memory and allows longer data acquisition times. For most waveform applications, the Gaussian filter is recommended, and it is the default filter for waveform measurements.
  - Res BW** - This key sets the measurement bandwidth. A larger bandwidth results in a larger number of acquisition points and reduces the maximum allowed for sweep time. You can enter values between 1.000 kHz. and 5.00000 MHz.
  - Decimation** - Allows you to toggle the decimation function between **On** and **Off** and to set the decimation value. Decimation allows longer acquisition times for a given bandwidth by eliminating data points. Long time captures can be limited by the transmitter tester data acquisition memory. Decimation numbers 0 to 4 describe the factor by which the number of points are reduced. Auto with a decimation figure of 0 is the default, this results in the firmware deciding the decimation factor.

## Using the Markers

The **Marker** front-panel key accesses the menu to configure the markers.

- **Select 1 2 3 4** - Allows you to activate up to four markers with the corresponding numbers, respectively. The selected number is underlined and its function is defined by pressing the **Function** key. The default is 1.
- **Normal** - Allows you to activate the selected marker to read the frequency and amplitude of the marker position on the spectrum trace, for example, which is controlled by the **RPG** knob.

## Making iDEN or WiDEN Measurements

### Making the MotoTalk Average Power (MT Avg Pwr) Measurement

- **Delta** - Allows you to read the differences in frequencies and amplitudes between the selected marker and the next.
- **Function Off** - Allows you to define the selected marker function to be **Band Power**, **Noise**, or **Off**. The default is **Off**. If set to **Band Power**, you need to select **Delta**.
- **Trace Spectrum** - Allows you to place the selected marker on the **Spectrum**, **Spectrum Avg**, or **I/Q Waveform** trace. The default is **Spectrum**.
- **Off** - Allows you to turn off the selected marker.
- **Shape Diamond** - Allows you to access the menu to define the selected marker shape to be a **Diamond**, **Line**, **Square**, or **Cross**. The default is a **Diamond**.
- **Marker All Off** - Allows you to turn off all of the markers.

The front panel **Search** key performs a peak search when pressed. A marker will automatically be activated at the highest peak.

---

#### NOTE

In the Waveform measurement, the Mean Pwr (Entire Trace) value plus the Pk-to-Mean value will sum to equal the current Max Pt. value as shown in the data window below the RF Envelope display. If you do a marker peak search (**Search**) with averaging turned off, the marker will find the same maximum point. However, if you turn averaging on, the Pk-to-Mean value will use the highest peak found for any acquisition during averaging, while the marker peak will look for the peak of the display, which is the result of n-averages. This will usually result in differing values for the maximum point.

---

### Band Power

A band power measurement using the markers calculates the average power between two adjustable markers. To make a band power measurement:

Press the **Marker** key.

Press **Function**, **Band Power**.

Two marker lines are activated at the extreme left side of the horizontal scale. Press **Normal** and move marker 1 to the desired place by rotating the **RPG** knob.

Press **Delta** to bring marker 2 to the same place as marker 1.

Move marker 1 to the other desired position by rotating the **RPG** knob. Band power measures the average power between the two markers. When the band power markers are active, the results are shown in the results window as Mean Pwr (Between MkS). When the band power function is off the results window reads Mean Pwr (Entire Trace).



## Troubleshooting Hints

Changes made by the user to advanced waveform settings can inadvertently result in measurements that are invalid and cause error messages to appear. Care needs to be taken when using advanced features.

---

## Making the MotoTalk Transient EVM (MT Trans EVM) Measurement

### Mode Availability

This measurement is available in the iDEN mode.

### Purpose

MotoTalk Transient EVM is used to measure modulation accuracy, carrier offset, and VCO settle time when frequency is hopping between two frequencies.

### Measurement Method

The measurement acquires **Meas Time** number of slots at center frequency, then tunes to the second frequency, which is **center frequency + Hop Freq Ofst**, and captures **Meas Time** number of slots. The measurement stitches two waveforms together, then demodulates each burst, and computes EVM. For each burst, both the RMS EVM of 270 symbols (excluding 2 windowed symbols at each end) as well as the peak EVM are reported. The average of all burst EVM and the peak EVM of all burst are also reported. To measure regular EVM (no hopping), set the **Hop Freq Ofst** to 0 Hz. The carrier offset is also measured and reported.

### Making the Measurement

---

**NOTE**

The factory default parameters provide a good starting point. You will likely want to change some of the settings. Press **Meas Setup, More, Restore Meas Defaults** at any time to return all parameters for the current measurement to their default settings.

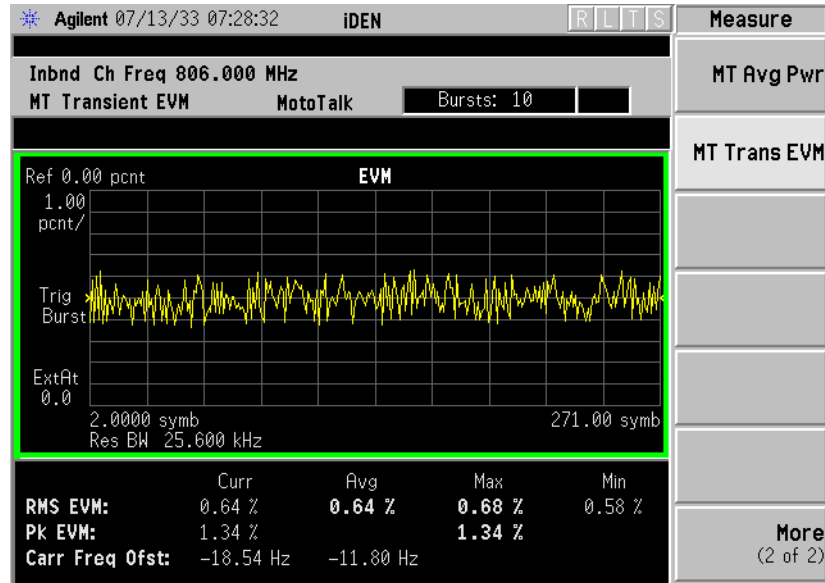
Press **Measure, MT Trans EVM** to immediately make MotoTalk Transient EVM the active measurement.

To change any of the measurement parameters from the factory default values, refer to the “[Changing the Measurement Setup](#)” section for this measurement.

## Results

Figure 3-13

### MotoTalk Transient EVM Measurement Results- RF Envelope Window



## Changing the Measurement Setup

Table 3-6

### MotoTalk Transient EVM Measurement Defaults

Measurement Parameter	Factory Default Condition
Hop Freq Ofst	0.0 Hz
Meas Time	10 slots
Trigger Source	RF Burst
<b>RF Envelope Window:</b>	
Amplitude Y Scale	
Scale/Div	1.0 pcnt
Reference	0.00 pcnt (Top)
<b>Advanced</b>	
Res BW	25.600 kHz
RBW Filter	Gaussian
Decimation	0 Auto

**NOTE**

Parameters that are under the **Advanced** key seldom need to be changed. Any changes from the default values may result in invalid measurement data.

Make sure the **MT Trans EVM** measurement is selected under the

**Measure** menu. Press the **Meas Setup** key to access a menu which allows you to modify the hopping frequency offset, measurement time and trigger source for this measurement (as described in “[Measurement Setup](#)” on page 42). In addition, the following parameters can be modified:

- **Hop Freq Ofst** - This key allows you to set the delta frequency between the hop-to-frequency and the center frequency. Values between 0.0 kHz and 6.00000 MHz can be entered.
- **Meas Time** - This key allows you to select the number of slots to capture. Values between 1 and 200 slots can be entered.
- **Advanced** menu key. This key accesses the features listed below.

**RBW Filter** - This key toggles to select a flat top or a Gaussian resolution bandwidth filter. A Gaussian filter provides more even time domain response, particularly for bursts. A flat top filter provides a flatter bandwidth but is less accurate for pulse responses. A flat top filter also requires less memory and allows longer data acquisition times. For most waveform applications, the Gaussian filter is recommended, and it is the default filter for waveform measurements.

**Res BW** - This key sets the measurement bandwidth. A larger bandwidth results in a larger number of acquisition points and reduces the maximum allowed for sweep time. You can enter values between 1.000 kHz. and 1.00000 MHz.

**Decimation** - Allows you to toggle the decimation function between **On** and **Off** and to set the decimation value. Decimation allows longer acquisition times for a given bandwidth by eliminating data points. Long time captures can be limited by the transmitter tester data acquisition memory. Decimation numbers 0 to 4 describe the factor by which the number of points are reduced. Auto with a decimation figure of 0 is the default, this results in the firmware deciding the decimation factor.

## Using the Markers

The **Marker** front-panel key accesses the menu to configure the markers. If you want to use the marker function in the I/Q window, press **View/Trace, I/Q Waveform, Marker, Trace, IQ Waveform**.

- **Select 1 2 3 4** - Allows you to activate up to four markers with the corresponding numbers, respectively. The selected number is underlined and its function is defined by pressing the **Function** key. The default is 1.
- **Normal** - Allows you to activate the selected marker to read the frequency and amplitude of the marker position on the spectrum trace, for example, which is controlled by the **RPG** knob.
- **Delta** - Allows you to read the differences in frequencies and amplitudes between the selected marker and the next.

- **Function Off** - Allows you to define the selected marker function to be **Band Power**, **Noise**, or **Off**. The default is **Off**. If set to **Band Power**, you need to select **Delta**.
- **Trace Spectrum** - Allows you to place the selected marker on the **Spectrum**, **Spectrum Avg**, or **I/Q Waveform** trace. The default is **Spectrum**.
- **Off** - Allows you to turn off the selected marker.
- **Shape Diamond** - Allows you to access the menu to define the selected marker shape to be a **Diamond**, **Line**, **Square**, or **Cross**. The default is a **Diamond**.
- **Marker All Off** - Allows you to turn off all of the markers.

The front panel **Search** key performs a peak search when pressed. A marker will automatically be activated at the highest peak.

---

#### NOTE

In the Waveform measurement, the Mean Pwr (Entire Trace) value plus the Pk-to-Mean value will sum to equal the current Max Pt. value as shown in the data window below the RF Envelope display. If you do a marker peak search (**Search**) with averaging turned off, the marker will find the same maximum point. However, if you turn averaging on, the Pk-to-Mean value will use the highest peak found for any acquisition during averaging, while the marker peak will look for the peak of the display, which is the result of n-averages. This will usually result in differing values for the maximum point.

---

### Band Power

A band power measurement using the markers calculates the average power between two adjustable markers. To make a band power measurement:

Press the **Marker** key.

Press **Function**, **Band Power**.

Two marker lines are activated at the extreme left side of the horizontal scale. Press **Normal** and move marker 1 to the desired place by rotating the **RPG** knob.

Press **Delta** to bring marker 2 to the same place as marker 1.

Move marker 1 to the other desired position by rotating the **RPG** knob. Band power measures the average power between the two markers. When the band power markers are active, the results are shown in the results window as Mean Pwr (Between Mks). When the band power function is off the results window reads Mean Pwr (Entire Trace).

[Making iDEN or WiDEN Measurements](#)

[Making the MotoTalk Transient EVM \(MT Trans EVM\) Measurement](#)

## Troubleshooting Hints

Changes made by the user to advanced waveform settings can inadvertently result in measurements that are invalid and cause error messages to appear. Care needs to be taken when using advanced features.

---

## Making the Spectrum (Frequency Domain) Measurement

### Mode Availability

This measurement is available in the iDEN and WiDEN mode.

### Purpose

The spectrum measurement provides spectrum analysis capability for the instrument. The control of the measurement was designed to be familiar to those who are accustomed to using swept spectrum analyzers.

This measurement is FFT (Fast Fourier Transform) based. The FFT-specific parameters are located in the **Advanced** menu. Also available under basic mode spectrum measurements is an I/Q window, which shows the I and Q signals in parameters of voltage and time. The advantage of having an I/Q view available while in the spectrum measurement is that it allows you to view complex components of the same signal without changing settings or measurements.

### Measurement Method

The transmitter tester uses digital signal processing to sample the input signal and convert it to the frequency domain. With the instrument tuned to a fixed center frequency, samples are digitized at a high rate, converted to I and Q components with DSP hardware, and then converted to the frequency domain with FFT software.

### Making the Measurement

---

#### NOTE

The factory default parameters provide a good starting point. You will likely want to change some of the settings. Press **Meas Setup, More (1 of 2), Restore Meas Defaults** at any time to return all parameters for the current measurement to their default settings.

Press **Measure, Spectrum (Freq Domain)** to immediately make Spectrum (Frequency Domain) the active measurement.

Press **Mode Setup, Radio, Inb Slot Format** to select the signal format. Except Full Slot Reserved, press **Color Code** to enter a number from 0 to 95 for the color code.

To change any of the measurement parameters from the factory default values, refer to the [“Changing the Measurement Setup”](#) section for this

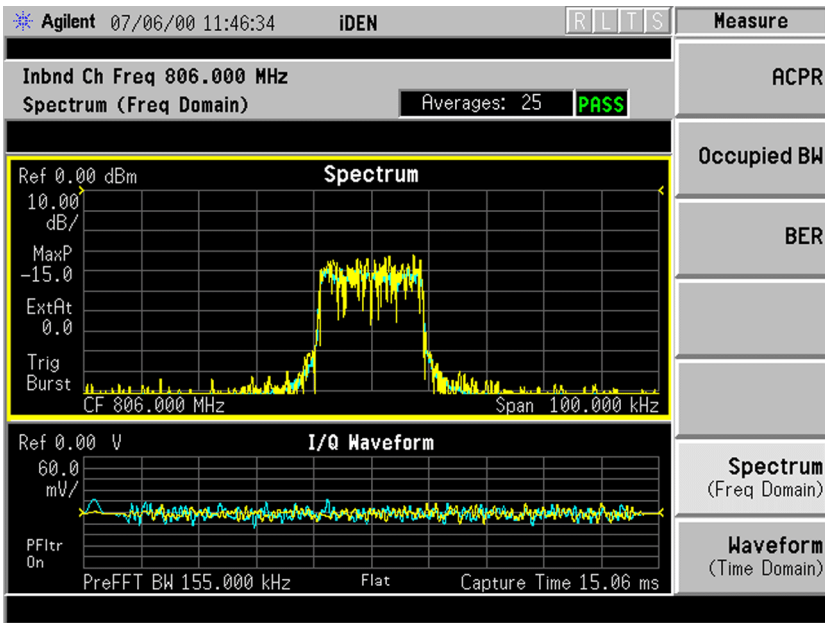
Making iDEN or WiDEN Measurements  
 Making the Spectrum (Frequency Domain) Measurement

measurement.

**Results**

A display with both a spectrum window and an I/Q Waveform window will appear when you activate a spectrum measurement. Use the **Next Window** key to select a window, and the **Zoom** key to enlarge a window.

**Figure 3-14** Spectrum Measurement Result- Spectrum Window





## Changing the Measurement Setup

Table 3-7

### Spectrum (Frequency Domain) Measurement Defaults

Measurement Parameter	Factory Default Condition	
	iDEN	WiDEN
Res BW	2 kHz	8 kHz
Averaging: Avg Number Avg Mode Avg Type	25 On Exp Log-Pwr Avg (Video)	25 On Exp Log-Pwr Avg (Video)
Trigger Source	RF Burst (Wideband)	RF Burst (Wideband)
Measurement Time (Service mode only)	1.0 ms (Auto)	1.0 ms (Auto)
<b>Spectrum Window:</b> Span Scale/Div - Amplitude Y Scale	100.000 kHz 10.00 dB	400.000 kHz 10.00 dB
<b>I/Q Waveform Window:</b> Capture Time Scale/Div - Amplitude Y Scale	15.06 ms 60 mV	15.06 ms 60 mV
<b>Advanced</b>		
Pre-ADC BPF	On	On
Pre-FFT Filter	Flat	Flat
Pre-FFT BW	155.000 kHz (Auto)	155.000 kHz (Auto)
FFT Window	Flat Top (High AmptdAcc)	Flat Top (High AmptdAcc)
FFT Size: Length Control Min Points/RBW Window Length FFT Length	Auto 31 706 1024	Auto 31 706 1024
ADC Range	Auto Peak	Auto Peak
Data Packing	Auto	Auto
ADC Dither	Auto	Auto
Decimation	0 (Auto)	0 (Auto)
IF Flatness	On	On

---

**NOTE**

---

Parameters under the **Advanced** key seldom need to be changed. Any changes from the default advanced values may result in invalid measurement data.

Make sure the **Spectrum (Freq Domain)** measurement is selected under the **Measure** menu. Press the **Meas Setup** key to access a menu which allows you to modify the averaging, and trigger source for this measurement (as described in “[Measurement Setup](#)” on page 42). In addition, the following parameters can be modified:

- **Span** - This key allows you to modify the frequency span. Changing the span causes the bandwidth to change automatically, and will affect data acquisition time.
- **Res BW** - This feature sets the resolution bandwidth for the FFT, and allows manual or automatic settings. A narrower bandwidth will result in a longer data acquisition time. In Auto mode the resolution bandwidth is set to Span/50 (2% of the span).
- **Advanced** - The following FFT advanced features should be used only if you are familiar with their operation. Changes from the default values may result in invalid data.

**Pre-ADC BPF** - This key allows you to toggle the pre-ADC bandpass filter to On or Off states. The pre-ADC bandpass filter is useful for rejecting nearby signals, so that sensitivity within the span range can be improved by increasing the ADC range gain.

**Pre-FFT Fltr** - Allows you to toggle between **Flat** (flat top) and **Gaussian**. The pre-FFT filter defaults to a flat top filter which has better amplitude accuracy. The Gaussian filter has better pulse response.

**Pre-FFT BW** - The Pre-FFT bandwidth allows you to select between a manual or an automatic setting. The pre FFT-bandwidth filter can be set between 1 Hz and 10 MHz. In Auto mode this bandwidth is nominally 50% wider than the span. This bandwidth determines the ADC sampling rate.

**FFT Window** - Allows you to access the following selection menu. Unless you are familiar with FFT windows, use the flat top filter (the default filter).

- **Flat Top** - Selects a filter for best amplitude accuracy, by reducing scalloping error.
- **Uniform** - You can select to have no window active by using the uniform setting.
- **Hanning**
- **Hamming**
- **Gaussian** - Selects a gaussian filter with an alpha of 3.5.
- **Blackman**
- **Blackman Harris**
- **K-B 70 dB / 90 dB / 110 dB (Kaiser-Bessel)** - Allows selection of Kaiser-Bessel filters with sidelobes of  $-70$ ,  $-90$ , or  $-110$  dBc.

**FFT Size** - This menu contains the following features:

- **Length Ctrl** - This feature allows you to set the FFT and window lengths either automatically or manually.
- **Min Pts in RBW** - This feature allows you to set the minimum number of data points that will be used inside the resolution bandwidth. This adjustment is only available if the **Length Ctrl** key is set to Auto.
- **Window Length** - This feature allows you to enter the FFT window length ranging from 8 to 1048576. This length represents the actual quantity of I/Q samples that are captured for processing by the FFT. This value can only be entered if length control is set to Manual.
- **FFT Length** - This feature allows you to enter the FFT length in the number of captured samples, ranging from 8 to 1048576. The FFT length setting is automatically limited so that it is equal or greater than the FFT window length setting. Any amount greater than the window length is implemented by zero-padding. This value can be entered only if length control is set to Man (manual).

**ADC Range** - Allows you to access the following selection menu to define one of the following ADC ranging functions:

- **Auto** - Select this to set the ADC range automatically. For most FFT spectrum measurements, the auto feature should not be selected. An exception is when measuring a signal which is “bursty”, in which case auto can maximize the time domain dynamic range, if FFT results are less important to you than time domain results.
- **Auto Peak** - Select this to set the ADC range automatically to the peak signal level. Auto peak is a compromise that works well for both CW and burst signals.

## Making iDEN or WiDEN Measurements

## Making the Spectrum (Frequency Domain) Measurement

- **AutoPeakLock** - Select this to hold the ADC range automatically at the peak signal level. Auto peak lock is more stable than auto peak for CW signals, but should not be used for “bursty” signals.
- **Manual** - Allows you to access the selection menu: **-6 dB, 0 dB, +6 dB, +12 dB, +18 dB, +24 dB** (with a 12 bit ADC installed) or **None, 0 dB, +6 dB, +12 dB, +18 dB**, (with a 14 bit ADC installed) to set the ADC range level. Also note that manual ranging is best for CW signals.

**Data Packing** - Allows you to access the following selection menu to define one of the following data packing methods:

- **Auto** - Data is automatically packed. This is the default setting and most recommended.
- **Short (16 bit)** - Data is packed by every 16 bits.
- **Medium (24 bit)** - Data is packed by every 24 bits.
- **Long (32 bit)** - Data is packed by every 32 bits.

**ADC Dither** - Allows you to toggle the ADC dither function between **Auto**, **On**, and **Off**. When set to auto (the default), ADC dither will be activated when a narrow bandwidth is being measured, and deactivated when a wide bandwidth is being measured. “ADC dither” refers to the introduction of noise to the digitized steps of the analog-to-digital converter; the result is an improvement in amplitude accuracy. Use of the ADC dither, however, reduces dynamic range by approximately 3 dB.

**Decimation** - Allows you to toggle the decimation function between **Auto** and **Man**, and to set the decimation value. **Auto** is the preferred setting, and the only setting that guarantees alias-free FFT spectrum measurements. If you are familiar with the decimation feature, you can change the decimation value by setting to **Man**, but be aware that aliasing can result in higher values.

**IF Flatness** - Allows you to toggle between **On** and **Off**. When toggled to **On** (the default), the IF flatness feature causes background amplitude corrections to be performed on the FFT spectrum. The **Off** setting is used for adjustment and troubleshooting the transmitter tester.

## Changing the View

View/Trace menu keys are used to activate a view of a measurement with preset X and Y scale parameters, called a “window”. Using the X and Y Scale keys you can then modify these parameter settings. You can also activate specific traces, using the **Trace Display** menu key.

### Windows Available for Spectrum Measurements

The spectrum and the I/Q windows can be viewed at the same time, or individually. You can use the Next Window and Zoom keys to move between these different views.

**Spectrum window** Select this window if you want to view frequency and power. Changes to frequency span or power will sometimes affect data acquisition.

**I/Q Waveform window.** Select this window to view the I and Q signal characteristics of the current measurement in parameters of voltage and time.

---

#### NOTE

For the widest spans the I/Q window becomes just “ADC time domain samples”, because the I/Q down-conversion is no longer in effect.

---

## Using the Markers

The **Marker** front-panel key accesses the menu to configure the markers. If you want to use the marker function in the I/Q window, press **View/Trace, I/Q Waveform, Marker, Trace, IQ Waveform**.

- **Select 1 2 3 4** - Allows you to activate up to four markers with the corresponding numbers, respectively. The selected number is underlined and its function is defined by pressing the **Function** key. The default is 1.
- **Normal** - Allows you to activate the selected marker to read the frequency and amplitude of the marker position on the spectrum trace, for example, which is controlled by the **RPG** knob.
- **Delta** - Allows you to read the differences in frequencies and amplitudes between the selected marker and the next.
- **Function Off** - Allows you to define the selected marker function to be **Band Power**, **Noise**, or **Off**. The default is **Off**. If set to **Band Power**, you need to select **Delta**.
- **Trace Spectrum** - Allows you to place the selected marker on the **Spectrum**, **Spectrum Avg**, or **I/Q Waveform** trace. The default is **Spectrum**.

## Making iDEN or WiDEN Measurements

### Making the Spectrum (Frequency Domain) Measurement

- **Off** - Allows you to turn off the selected marker.
- **Shape Diamond** - Allows you to access the menu to define the selected marker shape to be a **Diamond**, **Line**, **Square**, or **Cross**. The default is a **Diamond**.
- **Marker All Off** - Allows you to turn off all of the markers.

The front panel **Search** key performs a peak search when pressed. A marker will automatically be activated at the highest peak.

### Band Power

A band power measurement using the markers calculates the average power between two adjustable markers. To make a band power measurement:

Press the **Marker** key.

Press **Trace, Spectrum** to activate a marker on the instantaneous spectrum signal. Press the **Spectrum Avg** key to activate a marker on the average spectrum trace.

Press **Function, Band Power**.

Two marker lines are activated at the extreme left side of the horizontal scale. Press **Normal** and move marker 1 to the desired place by rotating the **RPG** knob.

Press **Delta** to bring marker 2 to the same place as marker 1.

Move marker 1 to the other desired position by rotating the **RPG** knob. Band power measures the average power between the two markers. When the band power markers are active, the results are shown in the results window as Mean Pwr (Between MkS). When the band power function is off the results window reads Mean Pwr (Entire Trace).

### Troubleshooting Hints

Changes made by the user to advanced spectrum settings, particularly to ADC range settings, can inadvertently result in spectrum measurements that are invalid and cause error messages to appear. Care needs to be taken when using advanced features.

---

## Making the Waveform (Time Domain) Measurement

### Mode Availability

This measurement is available in the iDEN and WiDEN mode.

### Purpose

The waveform measurement is a generic measurement for viewing waveforms in the time domain. This measurement is how the instrument performs the zero span functionality found in traditional spectrum analyzers. Also available under basic mode waveform measurements is an I/Q window, which shows the I and Q signal in parameters of voltage and time. The advantage of having an I/Q view available while in the waveform measurement is that it allows you to view complex components of the same signal without changing settings or measurements.

The waveform measurement can be used to perform general purpose power measurements to a high degree of accuracy.

### Measurement Method

The transmitter tester makes repeated power measurements at a set frequency, similar to the way a swept-tuned spectrum analyzer makes zero span measurements. The input analog signal is converted to a digital signal, which then is processed into a representation of a waveform measurement. The transmitter tester relies on a high rates of sampling to create an accurate representation of a time domain signal.

### Making the Measurement

---

#### NOTE

The factory default parameters provide a good starting point. You will likely want to change some of the settings. Press **Meas Setup, More (1 of 2), Restore Meas Defaults** at any time to return all parameters for the current measurement to their default settings.

Press **Measure, Waveform (Time Domain)** to immediately make Waveform (Time Domain) the active measurement.

Press **Mode Setup, Radio, Inb Slot Format** to select the signal format. Except Full Slot Reserved, press **Color Code** to enter a number from 0 to 95 for the color code.

To change any of the measurement parameters from the factory default

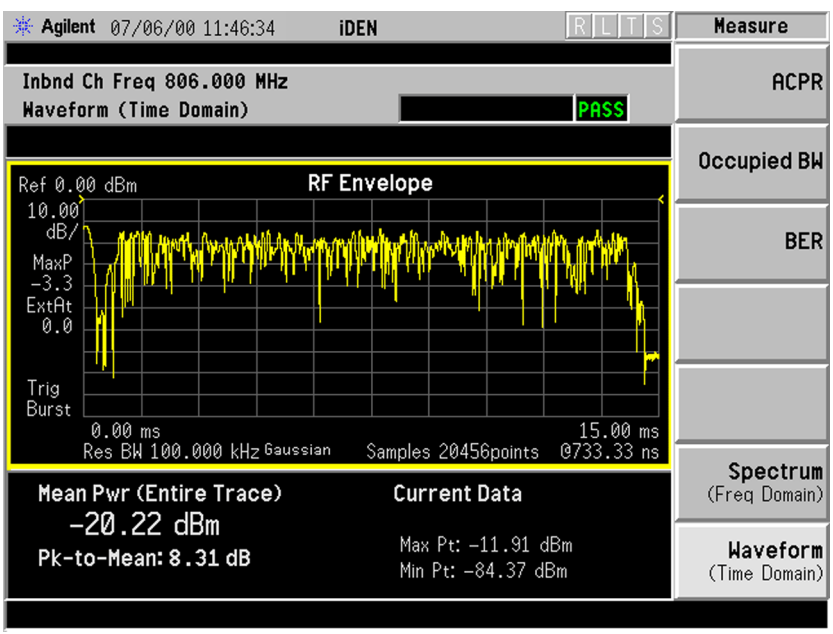
Making iDEN or WiDEN Measurements  
 Making the Waveform (Time Domain) Measurement

values, refer to the “Changing the Measurement Setup” section for this measurement.

**Results**

**Figure 3-15**

**Waveform Measurement Results- RF Envelope Window**





## Changing the Measurement Setup

**Table 3-8** Waveform (Time Domain) Measurement Defaults

Measurement Parameter	Factory Default Condition	
	iDEN	WiDEN
View/Trace	RF Envelope	RF Envelope
Sweep Time	15.00 ms	90.00 ms
Res BW	100.000 kHz	100.000 kHz
Averaging:		
Avg Number	10 Off	10 Off
Avg Mode	Exp	Exp
Avg Type	Pwr Avg (RMS)	Pwr Avg (RMS)
Trigger Source	RF Burst	RF Burst
<b>RF Envelope Window:</b>		
Amplitude Y Scale		
Scale/Div	10.00 dB	10.00 dB
Reference	0.00 dBm (Top)	0.00 dBm (Top)
<b>I/Q Waveform Window:</b>		
Amplitude Y Scale		
Scale/Div	100.0 mv	100.0 mv
Reference	0.00 V (Ctr)	0.00 V (Ctr)
<b>Advanced</b>		
Pre-ADC BPF	Off	Off
RBW Filter	Gaussian	Gaussian
ADC Range	Auto	Auto
Data Packing	Auto	Auto
ADC Dither	Off	Off
Decimation	Off	Off

**NOTE** Parameters that are under the **Advanced** key seldom need to be changed. Any changes from the default values may result in invalid measurement data.

## Making iDEN or WiDEN Measurements

### Making the Waveform (Time Domain) Measurement

Make sure the **Waveform (Time Domain)** measurement is selected under the **Measure** menu. Press the **Meas Setup** key to access a menu which allows you to modify the averaging, and trigger source for this measurement (as described in “[Measurement Setup](#)” on page 42). In addition, the following parameters can be modified:

- **Sweep Time** - This key allows you to select the measurement acquisition time. It is used to specify the length of the time capture record. Values between 10  $\mu$ s and 50 s can be entered, depending upon the resolution bandwidth setting.
- **Res BW** - This key sets the measurement bandwidth. A larger bandwidth results in a larger number of acquisition points and reduces the maximum allowed for sweep time. You can enter values between 10 Hz. and 7.5 MHz.
- **Advanced** menu key. This key accesses the features listed below.

**Pre-ADC BPF** - This key allows you to toggle the pre-ADC bandpass filter to On or Off states. The pre-ADC bandpass filter is useful for rejecting nearby signals, so that sensitivity within the span range can be improved by increasing the ADC range gain

**RBW Filter** - This key toggles to select a flat top or a Gaussian resolution bandwidth filter. A Gaussian filter provides more even time domain response, particularly for bursts. A flat top filter provides a flatter bandwidth but is less accurate for pulse responses. A flat top filter also requires less memory and allows longer data acquisition times. For most waveform applications, the Gaussian filter is recommended, and it is the default filter for waveform measurements.

**ADC Range** -.Allows you to access the following selection menu to define one of the following ADC ranging functions:

- **Auto** - This key causes the instrument to automatically adjust the signal range for optimal measurement results.
- **Auto Peak** - This key causes the instrument to continuously seek the highest peak signal.
- **AutoPeakLock** - This key causes the instrument to adjust the range for the highest peak signal it identifies, and retains the range settings determined by that peak signal, even when the peak signal is no longer present.
- **Manual** - Allows you to set the ADC range level. Note that manual ranging is best for CW signals.

**12 bit Digital IF** , The following selection menu is available:  
-6 dB, 0 dB, +6 dB, +12 dB, +18 dB, +24 dB.

**14 bit Digital IF** , The following selection menu is available:  
None, 0 dB, +6 dB, +12 dB, +18 dB.

**Data Packing** - Allows you to access the following selection menu to define one of the following data packing methods:

- **Auto** - Data is automatically packed. This is the default setting and most recommended.
- **Short (16 bit)** - Data is packed by every 16 bits.
- **Medium (24 bit)** - Data is packed by every 24 bits.
- **Long (32 bit)** - Data is packed by every 32 bits.

**ADC Dither** - Allows you to toggle the ADC dither function between **On** and **Off**. Activation of the ADC dither results in better amplitude linearity and resolution in low level signals. However, it also results in reduced dynamic range. ADC dither is set to **Off** by default.

**Decimation** - Allows you to toggle the decimation function between **On** and **Off** and to set the decimation value. Decimation allows longer acquisition times for a given bandwidth by eliminating data points. Long time captures can be limited by the transmitter tester data acquisition memory. Decimation numbers 1 to 4 describe the factor by which the number of points are reduced. A decimation figure of 1, which results in no data point reduction, is the default.

## Changing the View

The **View/Trace** menu keys are used to activate a view of a measurement with preset X and Y scale parameters; this view is called a “window.” Using the X and Y scale keys, you can then modify these parameters. You can also activate traces, using the **Traces Display** menu key.

### Windows Available for Waveform Measurements

**RF Envelope window.** Select this window if you want to view power (in dBm) vs. time. Remember that data acquisition will be affected when you change the sweep time.

**I/Q Waveform window.** Select this window to view the I and Q signal characteristics of the current measurement in parameters of voltage and time.

## Using the Markers

The **Marker** front-panel key accesses the menu to configure the markers. If you want to use the marker function in the I/Q window, press **View/Trace, I/Q Waveform, Marker, Trace, IQ Waveform**.

- **Select 1 2 3 4** - Allows you to activate up to four markers with the corresponding numbers, respectively. The selected number is underlined and its function is defined by pressing the **Function** key. The default is 1.

## Making iDEN or WiDEN Measurements

## Making the Waveform (Time Domain) Measurement

- **Normal** - Allows you to activate the selected marker to read the frequency and amplitude of the marker position on the spectrum trace, for example, which is controlled by the **RPG** knob.
- **Delta** - Allows you to read the differences in frequencies and amplitudes between the selected marker and the next.
- **Function Off** - Allows you to define the selected marker function to be **Band Power**, **Noise**, or **Off**. The default is **Off**. If set to **Band Power**, you need to select **Delta**.
- **Trace Spectrum** - Allows you to place the selected marker on the **Spectrum**, **Spectrum Avg**, or **I/Q Waveform** trace. The default is **Spectrum**.
- **Off** - Allows you to turn off the selected marker.
- **Shape Diamond** - Allows you to access the menu to define the selected marker shape to be a **Diamond**, **Line**, **Square**, or **Cross**. The default is a **Diamond**.
- **Marker All Off** - Allows you to turn off all of the markers.

The front panel **Search** key performs a peak search when pressed. A marker will automatically be activated at the highest peak.

**NOTE**

In the Waveform measurement, the Mean Pwr (Entire Trace) value plus the Pk-to-Mean value will sum to equal the current Max Pt. value as shown in the data window below the RF Envelope display. If you do a marker peak search (**Search**) with averaging turned off, the marker will find the same maximum point. However, if you turn averaging on, the Pk-to-Mean value will use the highest peak found for any acquisition during averaging, while the marker peak will look for the peak of the display, which is the result of n-averages. This will usually result in differing values for the maximum point.

**Band Power**

A band power measurement using the markers calculates the average power between two adjustable markers. To make a band power measurement:

Press the **Marker** key.

Press **Function**, **Band Power**.

Two marker lines are activated at the extreme left side of the horizontal scale. Press **Normal** and move marker 1 to the desired place by rotating the **RPG** knob.

Press **Delta** to bring marker 2 to the same place as marker 1.

Move marker 1 to the other desired position by rotating the **RPG** knob. Band power measures the average power between the two

markers. When the band power markers are active, the results are shown in the results window as Mean Pwr (Between Mks). When the band power function is off the results window reads Mean Pwr (Entire Trace).

## Troubleshooting Hints

Changes made by the user to advanced waveform settings can inadvertently result in measurements that are invalid and cause error messages to appear. Care needs to be taken when using advanced features.

Making iDEN or WiDEN Measurements  
Making the Waveform (Time Domain) Measurement

---

**4 iDEN and WiDEN Specifications**

The specifications for each measurement apply for the measurements when they are set to the factory default settings. All specifications apply over 0 °C to +55 °C, except when otherwise specified. The instrument will meet its specifications:

- after 2 hours of storage at a constant temperature
- within the operating temperature range
- 1 hour after the instrument is turned on
- within 24 hours after “Align All Now” has been run.



## Measurements

Measurement	Specifications	Supplemental Information
<b>Adjacent Channel Power Ratio</b>		
Carrier power range at UUT <sup>a</sup> Mobile station	+46 to -20 dBm	With ≥20 dB external atten.  0 to -70 dBc, characteristic For 18 kHz reference BW and 10 kHz offset BW.
Carrier power range at RF Input	+26 to -40 dBm	
Adjacent channel power ratio range at 25 kHz offset		
Resolution	0.01 dB	

a. UUT = Unit Under Test

Measurement	Specifications	Supplemental Information
<b>Occupied Bandwidth</b>		
Carrier power range at UUT Mobile station	+46 to -20 dBm	With ≥20 dB external atten.
Carrier power range at RF Input	+26 to -40 dBm	
Frequency resolution of occupied bandwidth	10 Hz	
Frequency accuracy of occupied bandwidth	300 Hz	
Frequency resolution of carrier frequency error	10 Hz	
Frequency accuracy of carrier frequency error		±50 Hz

Measurement	Specifications	Supplemental Information
<b>M16QAM Bit Error Rate</b>		
Carrier power range at UUT	+46 to -20 dBm	With $\geq 20$ dB external atten.
Carrier power range at RF Input	+26 to -40 dBm	
Minimum BER	< 1%	
Frequency error: Input frequency error range		$\pm 5$ kHz, characteristic
Frequency accuracy of carrier frequency		$\pm 10$ Hz, characteristic

Measurement	Specifications	Supplemental Information
<b>Waveform (Time Domain)</b>	See “Waveform Measurement” under Transmitter Tester Specifications (Measurements)	

Measurement	Specifications	Supplemental Information
<b>Spectrum</b>	See “Spectrum Measurement” under Transmitter Tester Specifications (Measurements)	

---

## Frequency

Measurements	Specifications	Supplemental Information
In-Band Frequency Range	700 to 1600 MHz	

## General

Measurements	Specifications	Supplemental Information
<b>Trigger</b>		
Trigger source		RF burst (wideband), Video (IF envelope), Ext Front, Ext Rear, Frame Timer. Actual available choices are dependent on measurement.  Default is video (IF envelope) for Occupied BW and BER. It is RF burst (wideband) for ACPR.
Trigger delay Range Accuracy Resolution	-500 to +500 ms ±33 ns 33 ns	
External trigger input Level Impedance		-5 to +5 V, characteristic >10 kΩ, nominal

Measurements	Specifications	Supplemental Information
<b>Measurement Speed</b>		
Adjacent channel power ratio	<= 4 s goal	<= 2 s goal
Bit error rate (M16QAM)	<= 4 s goal	<= 2 s goal
Occupied BW	<= 4 s goal	<= 2 s goal

---

**5****iDEN Programming Commands**

These commands are only available when the iDEN or WiDEN mode has been selected using INSTRUMENT:SElect. If iDEN or WiDEN mode is selected, commands that are unique to another mode are not available.

## SCPI Command Subsystems

- “CALCulate Subsystem” on page 103
- “CONFigure Subsystem” on page 124
- “DISPlay Subsystem” on page 125
- “FETCh Subsystem” on page 133
- “FORMat Subsystem” on page 134
- “INITiate Subsystem” on page 136
- “MEASure Group of Commands” on page 138
- “READ Subsystem” on page 168
- “SENSe Subsystem” on page 169

## CALCulate Subsystem

This subsystem is used to perform post-acquisition data processing. In effect, the collection of new data triggers the CALCulate subsystem. In this instrument, the primary functions in this subsystem are markers and limits.

### Adjacent Channel Power—Limit Test

**:CALCulate:ACP:LIMit:STATe OFF|ON|0|1**

**:CALCulate:ACP:LIMit:STATe?**

Turn limit test on or off.

Factory Preset  
 and \*RST: On

Remarks: You must be in Basic, cdmaOne, iDEN, WiDEN mode to use this command. Use INSTRument:SElect to set the mode.

### Bit Error Rate—Error Limit

**:CALCulate:BER:LIMit:ERATe <percent>**

**:CALCulate:BER:LIMit:ERATe?**

Set the percent error limit on the bit error rate.

Factory Preset: 5%

Range: 0.1 to 20% (iDEN)  
 0.0 to 20% (WiDEN)

Default Unit: Hz

Remarks: You must be in the iDEN, WiDEN mode to use this command. Use INSTRument:SElect to set the mode.

History: Version A.07.05 or later

Front Panel  
 Access: Meas Setup

### Bit Error Rate—Limit Testing

**:CALCulate:BER:LIMit:STATe OFF|ON|0|1**

**:CALCulate:BER:LIMit:STATe?**

Turn limit testing on or off.

Factory Preset: On

Remarks: You must be in the iDEN or WiDEN mode to use this command. Use INSTRUMENT:SElect to set the mode.

History: Version A.07.05 or later

## Query the Current Measurement Status

**:CALCulate:CLIMits:FAIL?**

Checks if the current measurement is outside its limits. It returns a 0 (zero) if it is passing or a 1 (one) if it is failing.

Front Panel

Access: None

## Data Query

**:CALCulate:DATA[n]?**

Returns the designated measurement data for the currently selected measurement and sub-opcode.

*n* = any valid sub-opcode for the current measurement. See the “MEASure Group of Commands” on page 138 for information on the data that can be returned for each measurement.

## Calculate/Compress Trace Data Query

**:CALCulate:DATA[n]:COMPRESS?**

**MAXimum|MEAN|MINimum|RMS|SAMPLE|SDEVIation|CFIT  
{, <soffset>}{, <length>}{, <roffset>}**

Returns the designated trace data for the currently selected measurement. The command can be used with sub-opcodes (*n*) for measurement results that are trace data. See the following table.

This command is used to compress/decimate a long trace to extract the desired data and only return to the computer the necessary data. A typical example would be to acquire N bursts of GSM data and return the mean power of each burst.

The command can also be used to identify the best curve fit for the data.

Curve Fit - applies curve fitting routines to the data. Where <soffset> and <length> are required, and <roffset> is an optional parameter for the desired order of the curve equation. The query will return the following values: the x-offset (in points) and the curve



coefficients ((order + 1) values).

<Start offset> - is an optional integer. It specifies the amount of data, at the beginning of the trace, that will be ignored before the decimation process starts. It is an integer index (that starts counting at zero) for all the elements in the trace. The default value is zero.

<Length> - is an optional integer that defines how many trace elements will be compressed into one value. This parameter has a default value equal to the current trace length.

<Repeat offset> - is an optional real number. It defines the beginning of the next field of trace elements to be compressed. This is relative to the beginning of the previous field. This parameter has a default value equal to the <length> variable. Select a number such that repeated additions will round to the correct starting index.

**Example:** To query the mean power of a set of GSM bursts:

1. Set the waveform measurement sweep time to acquire the required number of bursts.
2. Set the triggers such that acquisition happens at a known position relative to a burst.
3. Then query the mean burst levels using, **CALC:DATA2:COMP? MEAN, 62, 1315, 1442.3** (These parameter values correspond to GSM signals.)

**Remarks:** The optional parameters must be entered in the specified order. If you want to specify <length>, you must also specify <soffset> or it's default. (e.g. **CALC:DATA2:COMP? MEAN, 62, 1315**)

This command uses the data setting specified by the FORMat:DATA command and can return binary or ascii data.

**History:** Added in revision A.03.00 and later

Measurement	Available Traces	Markers Available?
ACP - adjacent channel power (Basic, cdmaOne, cdma2000, W-CDMA, iDEN, WiDEN, NADC, PDC modes)	no traces $(n=0)^a$ for I/Q points	no markers
BER - bit error rate (iDEN, WiDEN mode)	no traces $(n=0)^a$ for I/Q data	no markers

Measurement	Available Traces	Markers Available?
CDPower - code domain power (cdmaOne mode)	POWer ( $n=2$ ) <sup>a</sup> TIMing ( $n=3$ ) <sup>a</sup> PHASe ( $n=4$ ) <sup>a</sup> ( $n=0$ ) <sup>a</sup> for I/Q points	yes
CDPower - code domain power (cdma2000, W-CDMA modes)	CDPower ( $n=2$ ) <sup>a</sup> EVM ( $n=5$ ) <sup>a</sup> MERRor ( $n=6$ ) <sup>a</sup> PERRor ( $n=7$ ) <sup>a</sup> SPOWer ( $n=9$ ) <sup>a</sup> CPOWer ( $n=10$ ) <sup>a</sup> ( $n=0$ ) <sup>a</sup> for I/Q points	yes
CHPower - channel power (Basic, cdmaOne, cdma2000, W-CDMA modes)	SPECtrum ( $n=2$ ) <sup>a</sup> ( $n=0$ ) <sup>a</sup> for I/Q points	no markers
CSPur - spurs close (cdmaOne mode)	SPECtrum ( $n=2$ ) <sup>a</sup> ULIMit ( $n=3$ ) <sup>a</sup> ( $n=0$ ) <sup>a</sup> for I/Q points	yes
EEVM - EDGE error vector magnitude (EDGE mode)	EVMerror ( $n=2$ ) <sup>a</sup> MERRor ( $n=3$ ) <sup>a</sup> PERRor ( $n=4$ ) <sup>a</sup> ( $n=0$ ) <sup>a</sup> for I/Q points	yes
EORFspectr - EDGE output RF spectrum (EDGE mode)	RFEMod ( $n=2$ ) <sup>a</sup> RFESwitching ( $n=3$ ) <sup>a</sup> SPEMod ( $n=4$ ) <sup>a</sup> LIMMod ( $n=5$ ) <sup>a</sup> ( $n=0$ ) <sup>a</sup> for I/Q points	yes, only for a single offset  yes, only for multiple offsets

Measurement	Available Traces	Markers Available?
EPVTime - EDGE power versus time (EDGE mode)	RFENvelope ( $n=2$ ) <sup>a</sup> UMASk ( $n=3$ ) <sup>a</sup> LMASk ( $n=4$ ) <sup>a</sup> ( $n=0$ ) <sup>a</sup> for I/Q points	yes
ETSPur - EDGE transmit band spurs (EDGE mode)	SPECTrum ( $n=2$ ) <sup>a</sup> ULIMit ( $n=3$ ) <sup>a</sup> ( $n=0$ ) <sup>a</sup> for I/Q points	yes
EVM - error vector magnitude (NADC, PDC modes)	EVM ( $n=2$ ) <sup>a</sup> MERRor ( $n=3$ ) <sup>a</sup> PERRor ( $n=4$ ) <sup>a</sup> ( $n=0$ ) <sup>a</sup> for I/Q points	yes
EVMQpsk - QPSK error vector magnitude (cdma2000, W-CDMA modes)	EVM ( $n=2$ ) <sup>a</sup> MERRor ( $n=3$ ) <sup>a</sup> PERRor ( $n=4$ ) <sup>a</sup> ( $n=0$ ) <sup>a</sup> for I/Q points	yes
IM - intermodulation (cdma2000, W-CDMA modes)	SPECTrum ( $n=2$ ) <sup>a</sup> ( $n=0$ ) <sup>a</sup> for I/Q points	yes
MCPower - multi-carrier power (W-CDMA mode)	no traces ( $n=0$ ) <sup>a</sup> for I/Q points	no markers
OBW - occupied bandwidth (cdmaOne, cdma2000, iDEN, WiDEN, PDC, W-CDMA modes)	no traces ( $n=0$ ) <sup>a</sup> for I/Q points	no markers
ORFSpectrum - output RF spectrum (GSM, EDGE mode)	RFEMod ( $n=2$ ) <sup>a</sup> RFESwitching ( $n=3$ ) <sup>a</sup> SPEMod ( $n=4$ ) <sup>a</sup> LIMMod ( $n=5$ ) <sup>a</sup> ( $n=0$ ) <sup>a</sup> for I/Q points	yes, only for a single offset  yes, only for multiple offsets

iDEN Programming Commands

Measurement	Available Traces	Markers Available?
PFERror - phase and frequency error (GSM, EDGE mode)	PERRor ( $n=2$ ) <sup>a</sup> PFERror ( $n=3$ ) <sup>a</sup> RFENvelope ( $n=4$ ) <sup>a</sup> ( $n=0$ ) <sup>a</sup> for I/Q points	yes
PStatistic - power statistics CCDF (Basic, cdma2000, W-CDMA modes)	MEASured ( $n=2$ ) <sup>a</sup> GAUSian ( $n=3$ ) <sup>a</sup> REFerence ( $n=4$ ) <sup>a</sup> ( $n=0$ ) <sup>a</sup> for I/Q points	yes
PVTime - power versus time (GSM, EDGE, Service modes)	RFENvelope ( $n=2$ ) <sup>a</sup> UMASk ( $n=3$ ) <sup>a</sup> LMASk ( $n=4$ ) <sup>a</sup> ( $n=0$ ) <sup>a</sup> for I/Q points	yes
RHO - modulation quality (cdmaOne, cdma2000, W-CDMA mode)	( $n=0$ ) <sup>a</sup> for I/Q points EVM ( $n=2$ ) <sup>a</sup> MERRor ( $n=3$ ) <sup>a</sup> PERRor ( $n=4$ ) <sup>a</sup> ( $n=0$ ) <sup>a</sup> for I/Q points	yes
SEMask - spectrum emissions mask (cdma2000, W-CDMA mode)	SPECtrum ( $n=2$ ) <sup>a</sup> ( $n=0$ ) <sup>a</sup> for I/Q points	yes
TSPur - transmit band spurs (GSM, EDGE mode)	SPECtrum ( $n=2$ ) <sup>a</sup> ULIMit ( $n=3$ ) <sup>a</sup> ( $n=0$ ) <sup>a</sup> for I/Q points	yes
TXPower - transmit power (GSM, EDGE mode)	RFENvelope ( $n=2$ ) <sup>a</sup> IQ ( $n=8$ ) <sup>a</sup> ( $n=0$ ) <sup>a</sup> for I/Q points	yes

Measurement	Available Traces	Markers Available?
SPECTrum - (frequency domain) (all modes)	RFENvelope ( $n=2$ ) <sup>a</sup> for Service mode  IQ ( $n=3$ ) <sup>a</sup>  SPECTrum ( $n=4$ ) <sup>a</sup>  ASPECTrum ( $n=7$ ) <sup>a</sup>  ( $n=0$ ) <sup>a</sup> for I/Q points	yes
WAVEform - (time domain) (all modes)	RFENvelope ( $n=2$ ) <sup>a</sup> (also for Signal Envelope trace)  IQ ( $n=5$ ) <sup>a</sup>  ( $n=0$ ) <sup>a</sup> for I/Q points	yes

a. The  $n$  number indicates the sub-opcode that corresponds to this trace. Detailed descriptions of the trace data can be found in the MEASure subsystem documentation by looking up the sub-opcode for the appropriate measurement.

## Calculate Peaks of Trace Data

**:CALCulate:DATA[n]:PEAKs?**  
**<threshold>, <excursion> [, AMPLitude | FREQuency | TIME]**

Returns a list of peaks for the designated trace data  $n$  for the currently selected measurement. The peaks must meet the requirements of the peak threshold and excursion values.

The command can be used with sub-opcodes ( $n$ ) for any measurement results that are trace data. See the table above. Sub-opcode  $n=0$ , raw trace data cannot be searched for peaks. Both real and complex traces can be searched, but complex traces are converted to magnitude in dBm.

**Threshold** - is the level below which trace data peaks are ignored

**Excursion** - To be defined as a peak, the signal must rise above the threshold by a minimum amplitude change. Excursion is measured from the lowest point above the threshold (of the rising edge of the peak), to the highest signal point that begins the falling edge.

**Amplitude** - lists the peaks in order of descending amplitude, so the highest peak is listed first. This is the default peak order listing if the optional parameter is not specified.

Frequency - lists the peaks in order of occurrence, left to right across the x-axis

Time - lists the peaks in order of occurrence, left to right across the x-axis

Example: Select the spectrum measurement.

Use **CALC:DATA4:PEAK? -40,10,FREQ** to identify the peaks above -40 dBm, with excursions of at least 10 dB, in order of increasing frequency.

Query Results: Returns a list of floating-point numbers. The first value in the list is the number of peak points that follow. A peak point consists of two values: a peak amplitude followed by the its corresponding frequency (or time).

If no peaks are found the peak list will consist of only the number of peaks, (0).

The peak list is limited to 100 peaks. Peaks in excess of 100 are ignored.

Remarks: This command uses the data setting specified by the **FORMat:DATA** command and can return real 32-bit, real 64-bit, or ASCII data. The default data format is ASCII.

History: Added in revision A.03.00 and later

## CALCulate:MARKers Subsystem

Markers can be put on your displayed measurement data to supply information about specific points on the data. Some of the things that markers can be used to measure include: precise frequency at a point, minimum or maximum amplitude, and the difference in amplitude or frequency between two points.

When using the marker commands you must specify the measurement in the SCPI command. We recommend that you use the marker commands only on the current measurement. Many marker commands will return invalid results, when used on a measurement that is not current. (This is true for commands that do more than simply setting or querying an instrument parameter.) No error is reported for these invalid results.

You must make sure that the measurement is completed before trying to query the marker value. Using the **MEASure** or **READ** command, before the marker command, forces the measurement to complete before allowing the next command to be executed.

Each measurement has its own instrument state for marker

parameters. Therefore, if you exit the measurement, the marker settings in each measurement are saved and are then recalled when you change back to that measurement.

### **iDEN Mode - <measurement> key words**

- ACP - no markers
- BER - no markers
- OBW - no markers
- SPECTrum - markers available
- WAVeform - markers available

### **Example:**

Suppose you are using the Spectrum measurement. To position marker 2 at the maximum peak value, of the trace that marker 2 is currently on, the command is:

**:CALCulate:SPECTrum:MARKer2:MAXimum**

You must make sure that the measurement is completed before trying to query the marker value. Using the MEASure or READ command, before the marker command, forces the measurement to complete before allowing the next command to be executed.

### **Markers All Off on All Traces**

**:CALCulate:<measurement>:MARKer:AOff**

Turns off all markers on all the traces.

Example:           **CALC:SPEC:MARK:AOff**

Remarks:           The keyword for the current measurement must be specified in the command. (Some examples include: SPECTrum, WAVeform)

Front Panel

Access:           **Marker, More, Marker All Off**

### **Marker Function**

**:CALCulate:<measurement>:MARKer[1] | 2 | 3 | 4:FUNCTION  
BPOwer | NOISE | OFF**

**:CALCulate:<measurement>:MARKer[1] | 2 | 3 | 4:FUNCTION?**

Selects the type of marker for the specified marker. A particular measurement may not have all the types of markers that are commonly available.

The marker must have already been assigned to a trace. Use

**:CALCulate:<measurement>:MARKer [1] | 2 | 3 | 4:TRACe** to assign a marker to a particular trace.

Band Power – is the integrated power between the two markers for traces in the frequency domain and is the mean power between the two markers for traces in the time domain.

Noise – is the noise power spectral density in a 1 Hz bandwidth. It is averaged over 32 horizontal trace points.

Off – turns off the marker functions

Example:       **CALC:SPEC:MARK3:FUNC Noise**

Remarks:       The keyword for the current measurement must be specified in the command. (Some examples include: SPECTrum, WAVeform)

Front Panel

Access:         **Marker, Marker Function**

### Marker Function Result

**:CALCulate:<measurement>:MARKer [1] | 2 | 3 | 4:FUNCTION:RESult?**

Requires the result of the currently active marker function. The measurement must be completed before querying the marker. A particular measurement may not have all the types of markers available.

The marker must have already been assigned to a trace. Use **:CALCulate:<measurement>:MARKer [1] | 2 | 3 | 4:TRACe** to assign a marker to a particular trace.

Example:       **CALC:SPEC:MARK:FUNC:RES?**

Remarks:       The keyword for the current measurement must be specified in the command. (Some examples include: SPECTrum, WAVeform)

Front Panel

Access:         **Marker, Marker Function**

### Marker IQ

**:CALCulate:<measurement>:MARKer [1] | 2 | 3 | 4:IQ?**

When a marker is placed on an IQ trace, this command returns the I and Q of the marker position in volts.

The marker must have already been assigned to a trace. Use **:CALCulate:<measurement>:MARKer [1] | 2 | 3 | 4:TRACe** to assign a marker to a particular trace.



Example:           **CALC:SPEC:MARK:IQ4?**

Remarks:          The keyword for the current measurement must be specified in the command. (Some examples include: SPECTrum, WAVeform)

Front Panel

Access:           **Marker, Marker Function**

### Marker Peak (Maximum) Search

**:CALCulate:<measurement>:MARKer [1] | 2 | 3 | 4 :MAXimum**

Places the selected marker on the highest point on the trace that is assigned to that particular marker number.

The marker must have already been assigned to a trace. Use **:CALCulate:<measurement>:MARKer [1] | 2 | 3 | 4 :TRACe** to assign a marker to a particular trace.

Example:           **CALC:SPEC:MARK1:MAX**

Remarks:          The keyword for the current measurement must be specified in the command. (Some examples include: SPECTrum, WAVeform)

Front Panel

Access:           **Search**

### Marker Peak (Minimum) Search

**:CALCulate:<measurement>:MARKer [1] | 2 | 3 | 4 :MINimum**

Places the selected marker on the lowest point on the trace that is assigned to that particular marker number.

The marker must have already been assigned to a trace. Use **:CALCulate:<measurement>:MARKer [1] | 2 | 3 | 4 :TRACe** to assign a marker to a particular trace.

Example:           **CALC:SPEC:MARK2:MIN**

Remarks:          The keyword for the current measurement must be specified in the command. (Some examples include: SPECTrum, WAVeform)

Front Panel

Access:           None

## Marker Mode

```
:CALCulate:<measurement>:MARKer[1] | 2 | 3 | 4:MODE  
POSITION|DELTA
```

```
:CALCulate:<measurement>:MARKer[1] | 2 | 3 | 4:MODE?
```

Selects the type of marker to be a normal position-type marker or a delta marker. A specific measurement may not have both types of markers. For example, several measurements only have position markers.

The marker must have already been assigned to a trace. Use **:CALCulate:<measurement>:MARKer[1] | 2 | 3 | 4:TRACe** to assign a marker to a particular trace.

Example:       **CALC:SPEC:MARK:MODE DELTA**

Remarks:       For the delta mode only markers 1 and 2 are valid.  
  
                  The keyword for the current measurement must be specified in the command. (Some examples include: SPECTrum, WAVeform)

Front Panel

Access:         **Marker, Marker [Delta]**

## Marker On/Off

```
:CALCulate:<measurement>:MARKer[1] | 2 | 3 | 4[:STATe] OFF|ON|0|1
```

```
:CALCulate:<measurement>:MARKer[1] | 2 | 3 | 4[:STATe]?
```

Turns the selected marker on or off.

The marker must have already been assigned to a trace. Use **:CALCulate:<measurement>:MARKer[1] | 2 | 3 | 4:TRACe** to assign a marker to a particular trace.

Example:       **CALC:SPEC:MARK2: on**

Remarks:       The keyword for the current measurement must be specified in the command. (Some examples include: SPECTrum, AREFERENCE, WAVeform)  
  
                  The WAVeform measurement only has two markers available.

Front Panel

Access:         **Marker, Select then Marker Normal or Marker On Off**

## Marker to Trace

```
:CALCulate:<measurement>:MARKer[1] | 2 | 3 | 4:TRACe <trace_name>
```

**:CALCulate:<measurement>:MARKer [1] | 2 | 3 | 4 :TRACe?**

Assigns the specified marker to the designated trace. Not all types of measurement data can have markers assigned to them.

**Example:** With the WAVeform measurement selected, a valid command is **CALC:SPEC:MARK2:TRACE rfenvelope**.

**Range:** The names of valid traces are dependent upon the selected measurement. See the following table for the available trace names. The trace name assignment is independent of the marker number.

**Remarks:** The keyword for the current measurement must be specified in the command. (Some examples include: SPECTrum, WAVeform)

**Front Panel Access:** **Marker, Marker Trace**

Measurement	Available Traces	Markers Available?
ACP - adjacent channel power (Basic, cdmaOne, cdma2000, W-CDMA, iDEN (E4406A only), WiDEN (E4406A only), NADC, PDC modes)	no traces $(n=0)^a$ for I/Q points	no markers
BER - bit error rate (iDEN, WiDEN mode, E4406A only)	no traces $(n=0)^a$ for I/Q data	no markers
CDPower - code domain power (cdmaOne mode)	POWER $(n=2)^a$ TIMing $(n=3)^a$ PHASe $(n=4)^a$ $(n=0)^a$ for I/Q points	yes
CDPower - code domain power (cdma2000, W-CDMA, 1xEV-DO modes)	CDPower $(n=2)^a$ EVM $(n=5)^a$ MERRor $(n=6)^a$ PERRor $(n=7)^a$ SPOWer $(n=9)^a$ CPOWer $(n=10)^a$ $(n=0)^a$ for I/Q points	yes

iDEN Programming Commands

Measurement	Available Traces	Markers Available?
CHPower - channel power (Basic, cdmaOne, cdma2000, W-CDMA, 1xEV-DO modes)	SPECtrum ( $n=2$ ) <sup>a</sup> ( $n=0$ ) <sup>a</sup> for I/Q points	no markers
CSPur - spurs close (cdmaOne mode)	SPECtrum ( $n=2$ ) <sup>a</sup> ULIMit ( $n=3$ ) <sup>a</sup> ( $n=0$ ) <sup>a</sup> for I/Q points	yes
EEVM - EDGE error vector magnitude (EDGE mode)	EVMerror ( $n=2$ ) <sup>a</sup> MERRor ( $n=3$ ) <sup>a</sup> PERRor ( $n=4$ ) <sup>a</sup> ( $n=0$ ) <sup>a</sup> for I/Q points	yes
EORFspectr - EDGE output RF spectrum (EDGE mode)	RFEMod ( $n=2$ ) <sup>a</sup> RFESwitching ( $n=3$ ) <sup>a</sup> SPEMod ( $n=4$ ) <sup>a</sup> LIMMod ( $n=5$ ) <sup>a</sup> ( $n=0$ ) <sup>a</sup> for I/Q points	yes, only for a single offset  yes, only for multiple offsets
EPVTime - EDGE power versus time (EDGE mode)	RFENvelope ( $n=2$ ) <sup>a</sup> UMASk ( $n=3$ ) <sup>a</sup> LMASk ( $n=4$ ) <sup>a</sup> ( $n=0$ ) <sup>a</sup> for I/Q points	yes
ETSPur - EDGE transmit band spurs (EDGE mode)	SPECtrum ( $n=2$ ) <sup>a</sup> ULIMit ( $n=3$ ) <sup>a</sup> ( $n=0$ ) <sup>a</sup> for I/Q points	yes
EVM - error vector magnitude (NADC, PDC modes)	EVM ( $n=2$ ) <sup>a</sup> MERRor ( $n=3$ ) <sup>a</sup> PERRor ( $n=4$ ) <sup>a</sup> ( $n=0$ ) <sup>a</sup> for I/Q points	yes

Measurement	Available Traces	Markers Available?
EVMQpsk - QPSK error vector magnitude (cdma2000, W-CDMA, 1xEV-DO modes)	EVM ( $n=2$ ) <sup>a</sup> MERRor ( $n=3$ ) <sup>a</sup> PERRor ( $n=4$ ) <sup>a</sup> ( $n=0$ ) <sup>a</sup> for I/Q points	yes
IM - intermodulation (cdma2000, W-CDMA, 1xEV-DO modes)	SPECTrum ( $n=2$ ) <sup>a</sup> ( $n=0$ ) <sup>a</sup> for I/Q points	yes
MCPower - multi-carrier power (W-CDMA mode)	no traces ( $n=0$ ) <sup>a</sup> for I/Q points	no markers
OBW - occupied bandwidth (cdmaOne, cdma2000, iDEN (E4406A only), WiDEN (E4406A only), PDC, W-CDMA, 1xEV-DO modes)	no traces ( $n=0$ ) <sup>a</sup> for I/Q points	no markers
ORFSpectrum - output RF spectrum (GSM, EDGE mode)	RFEMod ( $n=2$ ) <sup>a</sup> RFESwitching ( $n=3$ ) <sup>a</sup> SPEMod ( $n=4$ ) <sup>a</sup> LIMMod ( $n=5$ ) <sup>a</sup> ( $n=0$ ) <sup>a</sup> for I/Q points	yes, only for a single offset  yes, only for multiple offsets
PFERror - phase and frequency error (GSM, EDGE mode)	PERRor ( $n=2$ ) <sup>a</sup> PFERror ( $n=3$ ) <sup>a</sup> RFENvelope ( $n=4$ ) <sup>a</sup> ( $n=0$ ) <sup>a</sup> for I/Q points	yes
PSTatistic - power statistics CCDF (Basic, cdma2000, W-CDMA, 1xEV-DO modes)	MEASured ( $n=2$ ) <sup>a</sup> GAUSSian ( $n=3$ ) <sup>a</sup> REFerence ( $n=4$ ) <sup>a</sup> ( $n=0$ ) <sup>a</sup> for I/Q points	yes
PVTime - power versus time (GSM, EDGE, 1xEV-DO, Service (E4406A only) modes)	RFENvelope ( $n=2$ ) <sup>a</sup> UMASk ( $n=3$ ) <sup>a</sup> LMASk ( $n=4$ ) <sup>a</sup> ( $n=0$ ) <sup>a</sup> for I/Q points	yes

iDEN Programming Commands

Measurement	Available Traces	Markers Available?
RHO - modulation quality (cdmaOne, cdma2000, W-CDMA, 1xEV-DO mode)	( $n=0$ ) <sup>a</sup> for I/Q points EVM ( $n=2$ ) <sup>a</sup> MERRor ( $n=3$ ) <sup>a</sup> PERRor ( $n=4$ ) <sup>a</sup> ( $n=0$ ) <sup>a</sup> for I/Q points	yes
SEMAsk - spectrum emissions mask (cdma2000, W-CDMA, 1xEV-DO mode)	SPECtrum ( $n=2$ ) <sup>a</sup> ( $n=0$ ) <sup>a</sup> for I/Q points	yes
TSPur - transmit band spurs (GSM, EDGE mode)	SPECtrum ( $n=2$ ) <sup>a</sup> ULIMit ( $n=3$ ) <sup>a</sup> ( $n=0$ ) <sup>a</sup> for I/Q points	yes
TXPower - transmit power (GSM, EDGE mode)	RFENvelope ( $n=2$ ) <sup>a</sup> IQ ( $n=8$ ) <sup>a</sup> ( $n=0$ ) <sup>a</sup> for I/Q points	yes
SPECtrum - (frequency domain) (all modes)	RFENvelope ( $n=2$ ) <sup>a</sup> for Service mode (E4406A only) IQ ( $n=3$ ) <sup>a</sup> SPECtrum ( $n=4$ ) <sup>a</sup> ASpectrum ( $n=7$ ) <sup>a</sup> ( $n=0$ ) <sup>a</sup> for I/Q points	yes
WAVEform - (time domain) (all modes)	RFENvelope ( $n=2$ ) <sup>a</sup> (also for Signal Envelope trace) IQ ( $n=5$ ) <sup>a</sup> ( $n=0$ ) <sup>a</sup> for I/Q points	yes

a. The  $n$  number indicates the sub-opcode that corresponds to this trace. Detailed descriptions of the trace data can be found in the MEASure subsystem documentation by looking up the sub-opcode for the appropriate measurement.

## Marker X Value

**:CALCulate:<measurement>:MARKer [1] | 2 | 3 | 4 :X <param>**

**:CALCulate:<measurement>:MARKer [1] | 2 | 3 | 4 :X?**

Position the designated marker on its assigned trace at the specified X value. The parameter value is in X-axis units (which is often frequency or time).

The marker must have already been assigned to a trace. Use

**:CALCulate:<measurement>:MARKer [1] | 2 | 3 | 4 :TRACe** to assign a marker to a particular trace.

The query returns the current X value of the designated marker. The measurement must be completed before querying the marker.

Example:       **CALC:SPEC:MARK2:X 1.2e6 Hz**

Default Unit:   Matches the units of the trace on which the marker is positioned

Remarks:       The keyword for the current measurement must be specified in the command. (Some examples include: SPECTrum, WAVeform)

Front Panel

Access:         **Marker, <active marker>, RPG**

## Marker X Position

**:CALCulate:<measurement>:MARKer [1] | 2 | 3 | 4 :X:POSition <integer>**

**:CALCulate:<measurement>:MARKer [1] | 2 | 3 | 4 :X:POSition?**

Position the designated marker on its assigned trace at the specified X position. A trace is composed of a variable number of measurement points. This number changes depending on the current measurement conditions. The current number of points must be identified before using this command to place the marker at a specific location.

The marker must have already been assigned to a trace. Use

**:CALCulate:<measurement>:MARKer [1] | 2 | 3 | 4 :TRACe** to assign a marker to a particular trace.

The query returns the current X position for the designated marker. The measurement must be completed before querying the marker.

Example:       **CALC:SPEC:MARK:X:POS 500**

Range:         0 to a maximum of (3 to 920,000)

Remarks:       The keyword for the current measurement must be specified in the command. (Some examples include:

SPECTrum, WAVeform)

Front Panel

Access: **Marker, <active marker>, RPG**

### Marker Readout Y Value

**:CALCulate:<measurement>:MARKer [1] | 2 | 3 | 4 :Y?**

Readout the current Y value for the designated marker on its assigned trace. The value is in the Y-axis units for the trace (which is often dBm).

The marker must have already been assigned to a trace. Use

**:CALCulate:<measurement>:MARKer [1] | 2 | 3 | 4 :TRACe** to assign a marker to a particular trace.

The measurement must be completed before querying the marker.

Example: **CALC:SPEC:MARK1:Y -20 dB**

Default Unit: Matches the units of the trace on which the marker is positioned

Remarks: The keyword for the current measurement must be specified in the command. (Some examples include: SPECTrum, WAVeform)

## Occupied Bandwidth - Limits

### Occupied Bandwidth—Frequency Band Limit

*PDC, W-CDMA, 1xEV-DO mode*

**:CALCulate:OBW:LIMit:FBLimit <freq>**

**:CALCulate:OBW:LIMit:FBLimit?**

*iDEN, WiDEN mode (E4406A only)*

**:CALCulate:OBWidth:LIMit:FBLimit <freq>**

**:CALCulate:OBWidth:LIMit:FBLimit?**

Set the frequency bandwidth limit in Hz.

Factory Preset: *WiDEN mode (E4406A)*

Carrier Configuration Setting	Default
Auto	Actual value depends on detected carrier configuration and cannot be changed.
25 kHz	20.0 kHz



Carrier Configuration Setting	Default
50 kHz	45.0 kHz
50 kHz outer	95.0 kHz
75 kHz	70.0 kHz
100 kHz	95.0 kHz

Factory Preset: 32 kHz for PDC

20 kHz for iDEN (E4406A only)

1.48 MHz for cdma2000, 1xEV-DO

5 MHz for W-CDMA

Range: 10 kHz to 60 kHz for PDC, iDEN (E4406A only)

10 kHz to 200 kHz for WiDEN (E4406A only)

10 kHz to 10 MHz for cdma2000, W-CDMA, 1xEV-DO

Default Unit: Hz

Remarks: You must be in the WiDEN, iDEN (E4406A only), PDC, cdma2000, W-CDMA, or 1xEV-DO mode to use this command. Use INSTRument:SElect to set the mode.

For E4406A WiDEN mode, if you have set the Carrier Config ([:SENSE]:RADio:CARRier[:TYPE]) to AUTO, the value is set to the default value described in “[Factory Preset:](#)” above according to the actual carrier config (you can see detected carrier configuration by sending [:SENSE]:RADio:CARRier[:TYPE]:ACTual?) You can not change this value. Even if the you set this value using SCPI, it is ignored and the default value is used.

History: For E4406A:

Version A.02.00 or later

Widen is available on Version A.07.05 or later

### Occupied Bandwidth—Limit Test

*PDC, cdma2000, W-CDMA, 1xEV-DO mode*

**:CALCulate:OBW:LIMit[:TEST] OFF|ON|0|1**

**:CALCulate:OBW:LIMit[:TEST]?**

*iDEN, WiDEN mode (E4406A only)*

**:CALCulate:OBwidth:LIMit:STATe OFF|ON|0|1**

**:CALCulate:OBWidth:LIMit:STATe?**

Turn the limit test function on or off.

Factory Preset: ON

Remarks: You must be in the iDEN (E4406A only), PDC, cdma2000, W-CDMA, or 1xEV-DO mode to use this command. Use INSTRument:SElect to set the mode.

History: For E4406A:  
Version A.02.00 or later  
Widen is available on Version A.07.05 or later

## Power vs. Time—Carrier Measurement

**:CALCulate:PVTime:CARRier[:SElect] ALL|C0|C1|C2|C3**

**:CALCulate:PVTime:CARRier[:SElect]?**

Enables you to set the carrier shown in the PvT measurement view. The PvT view shows the composite signal power vs. time trace. However, when you select C0, C1, C2 or C3, the SGC portion of the signal power (exactly, 1.05 ms to 1.45 ms from estimated  $t_{slot}$ ) is replaced by that of the selected carrier signal power rescaled by a factor determined by the number of carriers. When ALL is selected, the SGC portion is replaced by two traces. One trace of maximum power and one trace of minimum power calculated by a point-by-point comparison of up to 4 carriers.

Factory Preset  
and \*RST: On

Remarks: You must be in the WiDEN mode to use this command. Use INSTRument:SElect to set the mode.

History: Available on Version A.07.05 or later

Front Panel  
Access: **Meas Setup**

## Power vs. Time—Limit Test

**:CALCulate:PVTime:LIMit:STATe OFF|ON|0|1**

**:CALCulate:PVTime:LIMit:STATe?**

Turn limit testing on or off.

Factory Preset  
and \*RST: On

Remarks: You must be in the iDEN, WiDEN mode to use this

command. Use INSTRument:SElect to set the mode.

Front Panel  
Access:

**Meas Setup, Limit Test**

## CONFigure Subsystem

**:CONFigure:** <measurement>

The CONFigure commands are used with several other commands and are documented in the section on the [“MEASure Group of Commands”](#) on page 138.

## DISPlay Subsystem

The DISPlay controls the selection and presentation of textual, graphical, and TRACe information. Within a DISPlay, information may be separated into individual WINDows.

### Turn the Display On/Off

**:DISPlay:ENABle OFF | ON | 0 | 1**

**:DISPlay:ENABle?**

Controls the display. If enable is set to off, the display will appear to “freeze” in its current state. Measurements may run faster since the instrument doesn’t have to update the display after every data acquisition. There is often no need to update the display information when using remote operation. Turning the display off will also extend its life and reduce EMI. An instrument preset will turn the display back on.

Factory Preset: On

Remarks: The following key presses will turn display enable back on:

1. If in local, press any key
2. If in remote, press the local (system) key
3. If in local lockout (SYST:KLOCK), no key press will work

Front Panel

Access: **System, Disp Updates**

### Select Display Format

**:DISPlay:FORMat:ZOOM**

Selects the viewing format that displays only one window of the current measurement data (the current active window). Use DISP:FORM:TILE to return the display to multiple windows.

Front Panel

Access: **Zoom** (toggles between Tile and Zoom)

### PVT - View Selection

*iDEN, WiDEN mode*

**:DISPlay:PVTime:VIEW ALL|BOTH**

*All other modes*

**:DISPlay:PVTime:VIEW ALL|BOTH|A|B|C|D|E**

**:DISPlay:PVTime:VIEW?**

Select one of the power versus time measurement result views as follows:

ALL - displays the whole burst waveform throughout the all regions.

BOTH - displays both the rising and falling edges expanded in the horizontal scale.

A - display only the A region in the full horizontal scale.

B - display only the B region in the full horizontal scale.

C - display only the C region in the full horizontal scale.

D - display only the D region in the full horizontal scale.

E - display only the E region in the full horizontal scale.

Factory Preset: ALL

Remarks: You must be in the 1xEV-DO, iDEN, WiDEN, or W-CDMA mode to use this command. Use INSTRUMENT:SElect to set the mode.

Front Panel

Access: **Power vs Time, View/Trace**

## Spectrum - Y-Axis Reference Level

**:DISPlay:SPECTrum[n]:WINDow[m]:TRACe:Y[:SCALE]:RLEVel  
<power>**

**:DISPlay:SPECTrum[n]:WINDow[m]:TRACe:Y[:SCALE]:RLEVel?**

Sets the amplitude reference level for the y-axis.

n – selects the view, the default is Spectrum.

— n=1, Spectrum

— n=2, I/Q Waveform

— n=3, numeric data (service mode)

— n=4, RF Envelope (service mode)

m – selects the window within the view. The default is 1.

Factory Preset

and \*RST: 0 dBm, for Spectrum

Range: -250 to 250 dBm, for Spectrum  
 Default Unit: dBm, for Spectrum  
 Remarks: May affect input attenuator setting.  
 To use this command, the appropriate mode should be selected with INSTRUMENT:SElect.

Front Panel  
 Access: When in Spectrum measurement: **Amplitude Y Scale, Ref Level**

### Turn a Trace Display On/Off

**:DISPlay:TRACe [n] [:STATe] OFF|ON|0|1**

**:DISPlay:TRACe [n] [:STATe] ?**

Controls whether the specified trace is visible or not.

*n* is a sub-opcode that is valid for the current measurement. See the “MEASure Group of Commands” on page 138 for more information about sub-opcodes.

Factory Preset and \*RST: On

Range: The valid traces and their sub-opcodes are dependent upon the selected measurement. See the following table.

The trace name assignment is independent of the window number.

Remarks: To use this command, the appropriate mode should be selected with INSTRUMENT:SElect.

Front Panel  
 Access: **Display, Display Traces**

Measurement	Available Traces	Markers Available?
ACP - adjacent channel power (Basic, cdmaOne, cdma2000, W-CDMA, iDEN (E4406A only), WiDEN (E4406A only), NADC, PDC modes)	no traces  ( <i>n=0</i> ) <sup>a</sup> for I/Q points	no markers
BER - bit error rate (iDEN, WiDEN mode, E4406A only)	no traces  ( <i>n=0</i> ) <sup>a</sup> for I/Q data	no markers

Measurement	Available Traces	Markers Available?
CDPower - code domain power (cdmaOne mode)	POWer (n=2) <sup>a</sup> TIMing (n=3) <sup>a</sup> PHASe (n=4) <sup>a</sup> (n=0) <sup>a</sup> for I/Q points	yes
CDPower - code domain power (cdma2000, 1xEV-DO, W-CDMA modes)	(n=0) <sup>a</sup> for I/Q raw data CDPower (n=2) <sup>a</sup> EVM (n=5) <sup>a</sup> MERRor (n=6) <sup>a</sup> PERRor (n=7) <sup>a</sup> SPOWer (n=9) <sup>a</sup> CPOWer (n=10) <sup>a</sup>	yes
CHPower - channel power (Basic, cdmaOne, cdma2000, 1xEV-DO, W-CDMA modes)	SPECtrum (n=2) <sup>a</sup> (n=0) <sup>a</sup> for I/Q raw data	no markers
CSPur - spurs close (cdmaOne mode)	SPECtrum (n=2) <sup>a</sup> ULIMit (n=3) <sup>a</sup> (n=0) <sup>a</sup> for I/Q points	yes
EEVM - EDGE error vector magnitude (EDGE mode)	EVMerror (n=2) <sup>a</sup> MERRor (n=3) <sup>a</sup> PERRor (n=4) <sup>a</sup> (n=0) <sup>a</sup> for I/Q points	yes
EORFspectr - EDGE output RF spectrum (EDGE mode)	RFEMod (n=2) <sup>a</sup> RFESwitching (n=3) <sup>a</sup> SPEMod (n=4) <sup>a</sup> LIMMod (n=5) <sup>a</sup> (n=0) <sup>a</sup> for I/Q points	yes, only for a single offset  yes, only for multiple offsets



Measurement	Available Traces	Markers Available?
EPVTime - EDGE power versus time (EDGE mode)	RFENvelope ( $n=2$ ) <sup>a</sup> UMASk ( $n=3$ ) <sup>a</sup> LMASk ( $n=4$ ) <sup>a</sup> ( $n=0$ ) <sup>a</sup> for I/Q points	yes
ETSPur - EDGE transmit band spurs (EDGE mode)	SPECTrum ( $n=2$ ) <sup>a</sup> ULIMit ( $n=3$ ) <sup>a</sup> ( $n=0$ ) <sup>a</sup> for I/Q points	yes
EVM - error vector magnitude (NADC, PDC modes)	EVM ( $n=2$ ) <sup>a</sup> MERRor ( $n=3$ ) <sup>a</sup> PERRor ( $n=4$ ) <sup>a</sup> ( $n=0$ ) <sup>a</sup> for I/Q points	yes
EVMQpsk - QPSK error vector magnitude (cdma2000, 1xEV-DO, W-CDMA modes)	EVM ( $n=2$ ) <sup>a</sup> MERRor ( $n=3$ ) <sup>a</sup> PERRor ( $n=4$ ) <sup>a</sup> ( $n=0$ ) <sup>a</sup> for I/Q raw data	yes
IM - intermodulation (cdma2000, 1xEV-DO, W-CDMA modes)	SPECTrum ( $n=2$ ) <sup>a</sup> ( $n=0$ ) <sup>a</sup> for I/Q raw data	yes
MCPower - multi-carrier power (W-CDMA mode)	no traces ( $n=0$ ) <sup>a</sup> for I/Q points	no markers
OBW - occupied bandwidth (cdmaOne, cdma2000, 1xEV-DO, iDEN (E4406A only), WiDEN (E4406A only), PDC, W-CDMA modes)	no traces ( $n=0$ ) <sup>a</sup> for I/Q raw data	no markers
ORFSpectrum - output RF spectrum (GSM, EDGE mode)	RFEMod ( $n=2$ ) <sup>a</sup> RFESwitching ( $n=3$ ) <sup>a</sup> SPEMod ( $n=4$ ) <sup>a</sup> LIMMod ( $n=5$ ) <sup>a</sup> ( $n=0$ ) <sup>a</sup> for I/Q points	yes, only for a single offset  yes, only for multiple offsets

iDEN Programming Commands

Measurement	Available Traces	Markers Available?
PFERror - phase and frequency error (GSM, EDGE mode)	PERRor ( $n=2$ ) <sup>a</sup> PFERror ( $n=3$ ) <sup>a</sup> RFENvelope ( $n=4$ ) <sup>a</sup> ( $n=0$ ) <sup>a</sup> for I/Q points	yes
PStatistic - power statistics CCDF (Basic, cdma2000, 1xEV-DO, W-CDMA modes)	MEASured ( $n=2$ ) <sup>a</sup> GAUSian ( $n=3$ ) <sup>a</sup> REFerence ( $n=4$ ) <sup>a</sup> ( $n=0$ ) <sup>a</sup> for I/Q points	yes
PVTime - power versus time (GSM, EDGE, 1xEV-DO, Service (E4406A only) modes)	( $n=0$ ) <sup>a</sup> for I/Q raw data RFENvelope ( $n=2$ ) <sup>a</sup> UMASk ( $n=3$ ) <sup>a</sup> LMASk ( $n=4$ ) <sup>a</sup>	yes
RHO - modulation quality (cdmaOne, cdma2000, W-CDMA mode)	( $n=0$ ) <sup>a</sup> for I/Q raw data EVM ( $n=2$ ) <sup>a</sup> MERRor ( $n=3$ ) <sup>a</sup> PERRor ( $n=4$ ) <sup>a</sup> ( $n=5$ ) <sup>a</sup> for I/Q corrected trace data	yes
RHO - modulation quality (1xEV-DO mode)	( $n=0$ ) <sup>a</sup> for I/Q raw data ( $n=1$ ) <sup>a</sup> for various summary results EVM ( $n=2$ ) <sup>a</sup> MERRor ( $n=3$ ) <sup>a</sup> PERRor ( $n=4$ ) <sup>a</sup> ( $n=5$ ) <sup>a</sup> for I/Q corrected trace data	yes

Measurement	Available Traces	Markers Available?
SEMask - spectrum emissions mask (cdma2000, 1xEV-DO, W-CDMA mode)	SPECTrum ( $n=2$ ) <sup>a</sup>  ( $n=0$ ) <sup>a</sup> for I/Q raw data	yes
TSPur - transmit band spurs (GSM, EDGE mode)	SPECTrum ( $n=2$ ) <sup>a</sup>  ULIMit ( $n=3$ ) <sup>a</sup>  ( $n=0$ ) <sup>a</sup> for I/Q points	yes
TXPower - transmit power (GSM, EDGE mode)	RFENvelope ( $n=2$ ) <sup>a</sup>  IQ ( $n=8$ ) <sup>a</sup>  ( $n=0$ ) <sup>a</sup> for I/Q points	yes
SPECTrum - (frequency domain) (all modes)	RFENvelope ( $n=2$ ) <sup>a</sup> for Service mode (E4406A only)  IQ ( $n=3$ ) <sup>a</sup>  SPECTrum ( $n=4$ ) <sup>a</sup>  ASPectrum ( $n=7$ ) <sup>a</sup>  ( $n=0$ ) <sup>a</sup> for I/Q raw data	yes
WAVEform - (time domain) (all modes)	RFENvelope ( $n=2$ ) <sup>a</sup> (also for Signal Envelope trace)  IQ ( $n=5$ ) <sup>a</sup>  ( $n=0$ ) <sup>a</sup> for I/Q raw data	yes

a. The  $n$  number indicates the sub-opcode that corresponds to this trace. Detailed descriptions of the trace data can be found in the MEASure subsystem documentation by looking up the sub-opcode for the appropriate measurement.

### Waveform - Y-Axis Reference Level

```
:DISPlay:WAVEform[n]:WINDow[m]:TRACe:Y[:SCALE]:RLEVEL
<power>
```

```
:DISPlay:WAVEform[n]:WINDow[m]:TRACe:Y[:SCALE]:RLEVEL?
```

Sets the amplitude reference level for the y-axis.

n, selects the view, the default is RF envelope.

n=1, RF envelope

n=2, I/Q waveform

m, selects the window within the view. The default is 1.

Factory Preset

and \*RST: 0 dBm, for RF envelope

Range: -250 to 250 dBm, for RF envelope

Default Unit: dBm, for RF envelope

Remarks: May affect input attenuator setting.

To use this command, the appropriate mode should be selected with INSTRUMENT:SElect.

Front Panel

Access: When in Waveform measurement: **Amplitude Y Scale, Ref Level**

---

## FETCh Subsystem

**:FETCh: <measurement> [n] ?**

The FETCh? commands are used with several other commands and are documented in the section on the [“MEASure Group of Commands”](#) on [page 138](#).

---

## FORMat Subsystem

The FORMat subsystem sets a data format for transferring numeric and array information.

### Byte Order

**:FORMat:BORDER NORMAL | SWAPped**

**:FORMat:BORDER?**

Selects the binary data byte order for numeric data transfer. In normal mode the most significant byte is sent first. In swapped mode the least significant byte is first. (PCs use the swapped order.) Binary data byte order functionality does not apply to ASCII.

Factory Preset: Normal

Remarks: You must be in the Basic, cdma2000, 1xEV-DO, W-CDMA, GSM (w/EDGE), NADC, or PDC mode to use this command. Use INSTRument:SElect to set the mode.

### Numeric Data Format

**:FORMat[:DATA] ASCii | REAL,32 | REAL,64**

**:FORMat[:DATA]?**

VSA/PSA application modes: This command controls the format of data input/output, that is any data transfer across any remote port. The REAL and ASCII formats will format data in the current display units. The format of state data cannot be changed. It is always in a machine readable format only.

ASCII - Amplitude values are in ASCII, in amplitude units, separated by commas. ASCII format requires more memory than the binary formats. Therefore, handling large amounts of this type of data, will take more time and storage space.

Real,32 or Real,64 - Binary 32-bit (or 64-bit) real values in amplitude unit, in a definite length block. Transfers of real data are done in a binary block format.

A definite length block of data starts with an ASCII header that begins with # and indicates how many additional data points are following in the block. Suppose the header is #512320.

- The first digit in the header (5) tells you how many additional

digits/bytes there are in the header.

- The 12320 means 12 thousand, 3 hundred, 20 data bytes follow the header.
- Divide this number of bytes by your selected data format bytes/point, either 8 (for real 64), or 4 (for real 32). In this example, if you are using real 64 then there are 1540 points in the block.

Example:       FORM REAL,64

Factory Preset: ASCII

---

## INITiate Subsystem

The INITiate subsystem is used to initiate a trigger for a measurement. They only initiate measurements from the MEASURE front panel key or the “MEASure Group of Commands” on page 138. Refer to the TRIGger and ABORt subsystems for related commands.

### Take New Data Acquisition for Selected Measurement

**:INITiate:<measurement>**

This command initiates a trigger cycle for the measurement specified, but does not return data. The available measurement names are described in the MEASure subsystem.

If your selected measurement is not currently active it will change to the measurement in your INIT:<meas> command and initiate a trigger cycle.

Example:       INIT:ACP

### Continuous or Single Measurements

**:INITiate:CONTinuous OFF|ON|0|1**

**:INITiate:CONTinuous?**

Selects whether a trigger is continuously initiated or not. Each trigger initiates a single, complete, measurement operation.

When set to ON another trigger cycle is initiated at the completion of each measurement.

When set to OFF, the trigger system remains in the “idle” state until an INITiate[:IMMediate] command is received. On receiving the INITiate[:IMMediate] command, it will go through a single trigger/measurement cycle, and then return to the “idle” state.

Example:       INIT:CONT ON

Factory Preset: On

\*RST:           Off (recommended for remote operation)

Front Panel

Access:         **Meas Control, Measure Cont Single**



## Take New Data Acquisitions

### **:INITiate[:IMMEDIATE]**

The instrument must be in the single measurement mode. If INIT:CONT is ON, then the command is ignored. The desired measurement must be selected and waiting. The command causes the system to exit the “waiting” state and go to the “initiated” state.

The trigger system is initiated and completes one full trigger cycle. It returns to the “waiting” state on completion of the trigger cycle. Depending upon the measurement and the number of averages, there may be multiple data acquisitions, with multiple trigger events, for one full trigger cycle.

This command triggers the instrument, if external triggering is the type of trigger event selected. Otherwise, the command is ignored. Use the TRIGger[:SEQUENCE]:SOURce EXT command to select the external trigger.

Example:       INIT:IMM

Remarks:       See also the \*TRG command and the TRIGger subsystem.

Front Panel

Access:        **Meas Control, Measure Cont Single**

## Restart the Measurement

### **:INITiate:REStart**

This command applies to measurements found in the MEASURE menu. It restarts the current measurement from the “idle” state regardless of its current operating state. It is equivalent to:

INITiate[:IMMEDIATE]

ABORt (for continuous measurement mode)

Example:       INIT:RESt

Front Panel

Access:        **Restart**

or

**Meas Control, Restart**

---

## MEASure Group of Commands

This group includes commands used to make measurements and return results. The different commands can be used to provide fine control of the overall measurement process. Most measurements should be done in single measurement mode, rather than doing the measurement continuously.

Each measurement sets the instrument state that is appropriate for that measurement. Other commands are available for each **Mode** to allow changing settings, view, limits, etc. Refer to:

```
SENSE:<measurement>, SENSE:CHANnel, SENSE:CORRection,  
SENSE:FREQuency, SENSE:POWEr, SENSE:RADio, SENSE:SNYC  
CALCulate:<measurement>, CALCulate:CLIMits/DATA  
DISPlay:<measurement>  
TRIGger
```

### Measure Commands

**:MEASure :<measurement> [n] ?**

This is a fast single-command way to make a measurement using the factory default instrument settings. These are the settings and units that conform to the Standard.

- Stops the current measurement and sets up the instrument for the specified measurement using the factory defaults
- Initiates the data acquisition for the measurement
- Blocks other SCPI communication, waiting until the measurement is complete before returning results.
- After the data is valid it returns the scalar results, or the trace data, for the specified measurement.

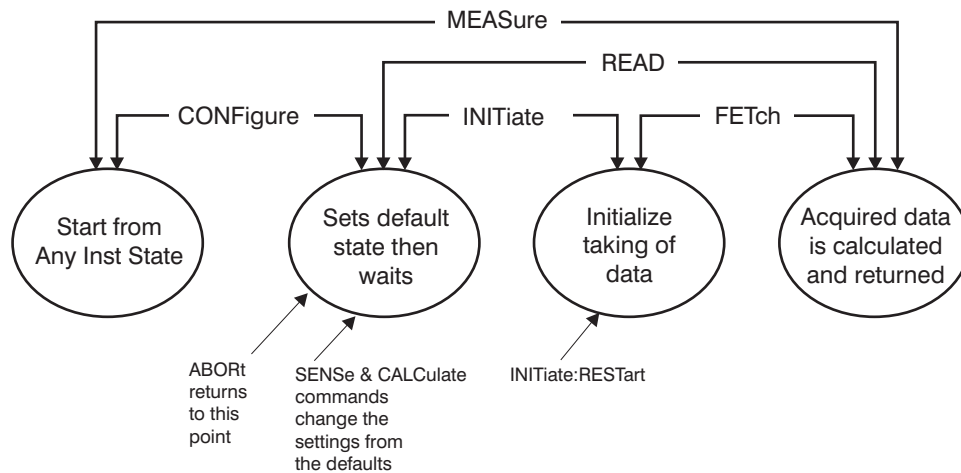
If the optional [n] value is not included, or is set to 1, the scalar measurement results will be returned. If the [n] value is set to a value other than 1, the selected trace data results will be returned. See each command for details of what types of scalar results or trace data results are available. The binary data formats should be used for handling large blocks of data since they are smaller and faster than the ASCII format.

If you need to change some of the measurement parameters from the factory default settings you can set up the measurement with the **CONFigure** command. Use the commands in the **SENSe:<measurement>** and **CALCulate:<measurement>** subsystems to change the settings. Then you can use the **READ?** command, or the **INITiate** and **FETCh?** commands, to initiate the measurement and query the results. See [Figure 5-1](#).

If you need to repeatedly make a given measurement with settings other than the factory defaults, you can use the commands in the **SENSe:<measurement>** and **CALCulate:<measurement>** subsystems to set up the measurement. Then use the **READ?** command or **INITiate** and **FETCh?** commands, to initiate the measurement and query results.

Measurement settings persist if you initiate a different measurement and then return to a previous one. Use **READ:<measurement>?** if you want to use those persistent settings. If you want to go back to the default settings, use **MEASure:<measurement>?**.

**Figure 5-1 Measurement Group of Commands**



## Configure Commands

### **:CONFigure:<measurement>**

This command sets up the instrument for the specified measurement using the factory default instrument settings and stops the current measurement. It does not initiate the taking of measurement data.

The **CONFigure?** query returns the current measurement name.

## Fetch Commands

### **:FETCh:<measurement>[n]?**

This command puts valid data into the output buffer, but does not initiate data acquisition. Use the INITiate[:IMMEDIATE] command to acquire data before you use the FETCh command. You can only fetch results from the measurement that is currently selected.

If the optional [n] value is not included, or is set to 1, the scalar measurement results will be returned. If the [n] value is set to a value other than 1, the selected trace data results will be returned. See each command for details of what types of scalar results or trace data results are available. The binary data formats should be used for handling large blocks of data since they are smaller and faster than the ASCII format.

## Read Commands

### **:READ:<measurement>[n]?**

- Does not preset the measurement to the factory defaults. (The MEASure? command does preset.) It uses the settings from the last measurement.
- Initiates the measurement and puts valid data into the output buffer. If a measurement other than the current one is specified, the instrument will switch to that measurement before it initiates the measurement and returns results.
- Blocks other SCPI communication, waiting until the measurement is complete before returning the results

If the optional [n] value is not included, or is set to 1, the scalar measurement results will be returned. If the [n] value is set to a value other than 1, the selected trace data results will be returned. See each command for details of what types of scalar results or trace data results are available. The binary data formats should be used when handling large blocks of data since they are smaller and faster than the ASCII format.

Measurement settings persist if you initiate a different measurement and then return to a previous one. Use READ:<measurement>? if you want to use those persistent settings. If you want to go back to the default settings, use MEASure:<measurement>?.

## Adjacent Channel Power Ratio (ACPR) Measurement

This measures the total rms power in the specified channel and in 5 offset channels. You must be in iDEN mode to use these commands. Use INSTRument:SElect to set the mode.

The general functionality of CONFIGure, FETCh, MEASure, and READ are described at the beginning of this section. See the SENSE:ACP commands for more measurement related commands.

**:CONFigure:ACPR**

**:FETCh:ACPR[n]?**

**:READ:ACPR[n]?**

**:MEASure:ACPR[n]?**

For Basic mode, a channel frequency and power level can be defined in the command statement to override the default standard setting. A comma must precede the power value as a place holder for the frequency, when no frequency is sent.

History: Added to Basic mode, version A.03.00 or later

Front Panel

Access: **Measure, ACPR**

After the measurement is selected, press **Restore Meas Defaults** to restore factory defaults.

### Measurement Results Available

Measurement Type	n	Results Returned
	0	Returns unprocessed I/Q trace data, as a series of trace point values, in volts. The I values are listed first in each pair, using the 0 through even-indexed values. The Q values are the odd-indexed values.
	n=1 (or not specified) NADC and PDC mode	Returns 22 scalar results, in the following order: <ol style="list-style-type: none"> <li>1. Center frequency – absolute power (dBm)</li> <li>2. Center frequency – absolute power (W)</li> <li>3. Negative offset frequency (1) – relative power (dB)</li> <li>4. Negative offset frequency (1) – absolute power (dBm)</li> <li>5. Positive offset frequency (1) – relative power (dB)</li> <li>6. Positive offset frequency (1) – absolute power (dBm)</li> </ol> <p style="text-align: center;">. . .</p> <ol style="list-style-type: none"> <li>1. Positive offset frequency (5) – relative power (dB)</li> <li>2. Positive offset frequency (5) – absolute power (dBm)</li> </ol>

Measurement Type	n	Results Returned
	not specified or n=1  iDEN, WiDEN mode	Returns 11 comma-separated scalar results for iDEN and 19 comma-separated scalar results for WiDEN, in the following order: <ol style="list-style-type: none"> <li>1. Center freq – relative power (dB)</li> <li>2. Center freq – absolute power (dBm)</li> <li>3. Lower offset freq – relative power (dB)</li> <li>4. Lower offset freq– absolute power (dBm)</li> <li>5. Upper offset freq – relative power (dB)</li> <li>6. Upper offset freq – absolute power (dBm)</li> <li>7. Total power (dBm)</li> <li>8. Offset frequency (Hz)</li> <li>9. Reference BW (Hz)</li> <li>10. Offset BW (Hz)</li> <li>11. Reserved for future use.</li> <li>12. Reserved for future use.</li> <li>13. Carrier/center frequency (Hz)</li> <li>14. Lower offset freq of offset B – relative power (dB). If the carrier is selected any options except 50 kHz outer, returns –999. (WiDEN mode only)</li> <li>15. Lower offset freq of offset B – absolute power (dBm). If the carrier is selected any options except 50 kHz outer, returns –999. (WiDEN mode only)</li> <li>16. Upper offset freq of offset B – relative power (dB). If the carrier is selected any options except 50 kHz outer, returns –999. (WiDEN mode only)</li> <li>17. Upper offset freq of offset B – absolute power (dBm). If the carrier is selected any options except 50 kHz outer, returns –999. (WiDEN mode only)</li> <li>18. Offset frequency of offset B (Hz). if the carrier is selected any options except 50 kHz outer, returns –999. (WiDEN mode only)</li> <li>19. Offset BW for of offset B (Hz). If the carrier is selected any options except 50 kHz outer, returns –999. (WiDEN mode only)</li> </ol>

Measurement Type	n	Results Returned
Total power reference	n=1 (or not specified) Basic, cdmaOne, cdma2000, W-CDMA mode	<p>Returns 24 scalar results, in the following order:</p> <ol style="list-style-type: none"> <li>1. Center frequency - relative power (dB)</li> <li>2. Center frequency - absolute power (dBm)</li> <li>3. Center frequency - relative power (dB) (same as value 1)</li> <li>4. Center frequency - absolute power (dBm) (same as value 2)</li> <li>5. Negative offset frequency (1) - relative power (dB),</li> <li>6. Negative offset frequency (1) - absolute power (dBm)</li> <li>7. Positive offset frequency (1) - relative power (dB)</li> <li>8. Positive offset frequency (1) - absolute power (dBm)</li> </ol> <p style="text-align: center;">. . .</p> <ol style="list-style-type: none"> <li>1. Positive offset frequency (5) - relative power (dB)</li> <li>2. Positive offset frequency (5) - absolute power (dBm)</li> </ol> <hr/> <p><b>NOTE</b> Center frequency relative power is relative to the center frequency absolute power and therefore, is always equal to 0.00 dB.</p>
Power spectral density reference	n=1 (or not specified) Basic, cdmaOne, cdma2000, W-CDMA mode	<p>Returns 24 scalar results, in the following order:</p> <ol style="list-style-type: none"> <li>1. Center frequency - relative power (dB)</li> <li>2. Center frequency - absolute power (dBm/Hz)</li> <li>3. Center frequency - relative power (dB) (same as value 1)</li> <li>4. Center frequency - absolute power (dBm/Hz) (same as value 2)</li> <li>5. Negative offset frequency (1) - relative power (dB)</li> <li>6. Negative offset frequency (1) - absolute power (dBm/Hz)</li> <li>7. Positive offset frequency (1) - relative power (dB)</li> <li>8. Positive offset frequency (1) - absolute power (dBm/Hz)</li> </ol> <p style="text-align: center;">. . .</p> <ol style="list-style-type: none"> <li>1. Positive offset frequency (5) - relative power (dB)</li> <li>2. Positive offset frequency (5) - absolute power (dBm/Hz)</li> </ol> <hr/> <p><b>NOTE</b> Center frequency relative power is relative to the center frequency absolute power and therefore, is always equal to 0.00 dB.</p>
	2 NADC and PDC mode	<p>Returns 10 scalar values of the pass/fail (0 = passed, or 1 = failed) results determined by testing the absolute power of the offset frequencies:</p> <ol style="list-style-type: none"> <li>1. Negative offset frequency (1) absolute power</li> <li>2. Positive offset frequency (1) absolute power</li> </ol> <p style="text-align: center;">. . .</p> <ol style="list-style-type: none"> <li>1. Negative offset frequency (5) absolute power</li> <li>2. Positive offset frequency (5) absolute power</li> </ol>

Measurement Type	n	Results Returned
	2 iDEN, WiDEN mode	<p>Returns comma-separated scalar values of the histogram absolute power trace, 3 values for iDEN and 6 values for WiDEN. The elements of the array are different according to the following two conditions:</p> <p>(case a) The actual carrier config is 50 kHz outer (WiDEN mode only):</p> <ol style="list-style-type: none"> <li>1. Lower offset frequency of offset A – absolute power (dBm) (WiDEN mode only)</li> <li>2. Reference frequency – absolute power (dBm). (WiDEN mode only)</li> <li>3. Lower offset frequency of offset B – absolute power (dBm). (WiDEN mode only)</li> <li>4. Upper offset frequency of offset B – absolute power (dBm). (WiDEN mode only)</li> <li>5. Reference frequency – absolute power (dBm) – duplicated. (WiDEN mode only)</li> <li>6. Upper offset frequency of offset A – absolute power (dBm). (WiDEN mode only)</li> </ol> <p>(case b) Otherwise</p> <ol style="list-style-type: none"> <li>1. Lower offset frequency of offset A – absolute power (dBm).</li> <li>2. Reference frequency – absolute power (dBm).</li> <li>3. Upper offset frequency of offset A – absolute power (dBm).</li> <li>4. Returns –999. (WiDEN mode only)</li> <li>5. Returns –999. (WiDEN mode only)</li> <li>6. Returns –999. (WiDEN mode only)</li> </ol>
Total power reference	2 Basic, cdmaOne, cdma2000, W-CDMA mode	<p>Returns 11 scalar values (in dBm) corresponding to the total power histogram display. The values are returned in ascending frequency order:</p> <ol style="list-style-type: none"> <li>1. Negative offset frequency (5)</li> <li>2. Negative offset frequency (4)</li> <li>3. Negative offset frequency (3)</li> </ol> <p>...</p> <ol style="list-style-type: none"> <li>1. Center frequency</li> <li>2. Positive offset frequency (1)</li> <li>3. Positive offset frequency (2)</li> </ol> <p>...</p> <ol style="list-style-type: none"> <li>1. Positive offset frequency (5)</li> </ol>



Measurement Type	n	Results Returned
	3 NADC and PDC mode	Returns 10 scalar values of the pass/fail (0 = passed, or 1 = failed) results determined by testing the relative power of the offset frequencies: <ol style="list-style-type: none"> <li>1. Negative offset frequency (1) relative power</li> <li>2. Positive offset frequency (1) relative power</li> <li style="text-align: center;">. . .</li> <li>1. Negative offset frequency (5) relative power</li> <li>2. Positive offset frequency (5) relative power</li> </ol>
	3 iDEN, WiDEN mode	Returns comma-separated scalar values of the histogram relative power trace, 3 values for iDEN and 6 values for WiDEN. The elements of the array are different according to the following two conditions: <p>(case a) The actual carrier config is 50 kHz outer (WiDEN mode only):</p> <ol style="list-style-type: none"> <li>1. Lower offset frequency of offset A – relative power (dBc) (WiDEN mode only)</li> <li>2. Reference frequency – relative power (dBc). (WiDEN mode only)</li> <li>3. Lower offset frequency of offset B – relative power (dBc). (WiDEN mode only)</li> <li>4. Upper offset frequency of offset B – relative power (dBc). (WiDEN mode only)</li> <li>5. Reference frequency – relative power (dBc) – duplicated. (WiDEN mode only)</li> <li>6. Upper offset frequency of offset A – relative power (dBc). (WiDEN mode only)</li> </ol> <p>(case b) Otherwise</p> <ol style="list-style-type: none"> <li>1. Lower offset frequency of offset A – relative power (dBc).</li> <li>2. Reference frequency – relative power (dBc).</li> <li>3. Upper offset frequency of offset A – relative power (dBc).</li> <li>4. Returns –999. (WiDEN mode only)</li> <li>5. Returns –999. (WiDEN mode only)</li> <li>6. Returns –999. (WiDEN mode only)</li> </ol>

Measurement Type	n	Results Returned
Power spectral density reference	3 Basic, cdmaOne, cdma2000, W-CDMA mode	Returns 11 scalar values (in dBm/Hz) corresponding to the power spectral density histogram display. The values are returned in ascending frequency order:  1. Negative offset frequency (5) 2. Negative offset frequency (4)  . . .  1. Center frequency 2. Positive offset frequency (1)  . . .  1. Positive offset frequency (5)
	4 NADC and PDC mode	Returns the frequency-domain spectrum trace (data array) for the entire frequency range being measured.  In order to return spectrum data, the ACP display must be in the spectrum view and you must not turn off the spectrum trace.
	4 iDEN, WiDEN mode	Returns comma-separated absolute power results for the reference and offset channels, 4 values for iDEN and 6 values for WiDEN.  Reference channel – absolute power. Reference channel – absolute power (duplicate of above). Lower offset channel of offset A– absolute power (dBm). Upper offset channel of offset A– absolute power (dBm). Lower offset channel of offset B– absolute power (dBm). If the carrier is selected any options except 50 kHz outer, returns –999. (WiDEN mode only) Upper offset channel of offset B– absolute power (dBm). If the carrier is selected any options except 50 kHz outer, returns –999. (WiDEN mode only)

Measurement Type	n	Results Returned
(For cdma2000 and W-CDMA the data is only available with spectrum display selected)	4 Basic, cdmaOne, cdma2000, W-CDMA mode	<p>Returns the frequency-domain spectrum trace data for the entire frequency range being measured.</p> <p>With the spectrum view selected (DISPlay:ACP:VIEW SPECTrum) and the spectrum trace on (SENSe:ACP:SPECTrum:ENABLE):</p> <ul style="list-style-type: none"> <li>In FFT mode (SENSe:ACP:SWEep:TYPE FFT) the number of trace points returned are 343 (cdma2000) or 1715 (W-CDMA). This is with the default span of 5 MHz (cdma2000) or 25 MHz (W-CDMA). The number of points also varies if another offset frequency is set.</li> <li>In sweep mode (SENSe:ACP:SWEep:TYPE SWEep), the number of trace points returned is 601 (for cdma2000 or W-CDMA) for any span.</li> </ul> <p>With bar graph display selected, one point of -999.0 will be returned.</p>
	5 iDEN, WiDEN mode	<p>Returns comma-separated relative power results for the reference and offset channels, 4 values for iDEN and 6 values for WiDEN.</p> <p>Reference channel – relative power.          Reference channel – relative power (duplicate of above).          Lower offset channel of offset A– relative power (dBc).          Upper offset channel of offset A– relative power (dBc).          Lower offset channel of offset B– relative power (dBc). If the carrier is selected any options except 50 kHz outer, returns -999. (WiDEN mode only)          Upper offset channel of offset B– relative power (dBc). If the carrier is selected any options except 50 kHz outer, returns -999. (WiDEN mode only)</p>
Total power reference	5 Basic, cdmaOne, cdma2000, W-CDMA mode	<p>Returns 12 scalar values (in dBm) of the absolute power of the center and the offset frequencies:</p> <ol style="list-style-type: none"> <li>Upper adjacent chan center frequency</li> <li>Lower adjacent chan center frequency</li> <li>Negative offset frequency (1)</li> <li>Positive offset frequency (1)</li> </ol> <p>...</p> <ol style="list-style-type: none"> <li>Negative offset frequency (5)</li> <li>Positive offset frequency (5)</li> </ol>

Measurement Type	n	Results Returned
Power spectral density reference	5 Basic, cdmaOne, cdma2000, W-CDMA mode	Returns 12 scalar values (in dBm/Hz) of the absolute power of the center and the offset frequencies:  1. Upper adjacent chan center frequency 2. Lower adjacent chan center frequency 3. Negative offset frequency (1) 4. Positive offset frequency (1)  . . .  1. Negative offset frequency (5) 2. Positive offset frequency (5)
	6 iDEN, WiDEN mode	Returns comma-separated pass(0)/fail(1) test results for the absolute power of the reference and offset channels, 4 values for iDEN and 6 values for WiDEN.  Reference channel – absolute power pass/fail (returned as always PASSED). Reference channel – absolute power pass/fail (returned as always PASSED) (duplicate of above). Lower offset channel of offset A– absolute power pass/fail. Upper offset channel of offset A– absolute power pass/fail. Lower offset channel of offset B– absolute power pass/fail. If the carrier is selected any options except 50 kHz outer, returns 0 (passed). (WiDEN mode only) Upper offset channel of offset B– absolute power pass/fail. If the carrier is selected any options except 50 kHz outer, returns 0/Passed. (WiDEN mode only)
Total power reference	6 Basic, cdmaOne, cdma2000, W-CDMA mode	Returns 12 scalar values (total power in dB) of the power relative to the carrier at the center and the offset frequencies:  1. Upper adjacent chan center frequency 2. Lower adjacent chan center frequency 3. Negative offset frequency (1) 4. Positive offset frequency (1) 5. Negative offset frequency (5)  . . .  1. Negative offset frequency (5) 2. Positive offset frequency (5)

iDEN Programming Commands

Measurement Type	n	Results Returned
Power spectral density reference	6 Basic, cdmaOne, cdma2000, W-CDMA mode	Returns 12 scalar values (power spectral density in dB) of the power relative to the carrier at the center and offset frequencies:  1. Upper adjacent chan center frequency 2. Lower adjacent chan center frequency 3. Negative offset frequency (1) 4. Positive offset frequency (1)  . . .  1. Negative offset frequency (5) 2. Positive offset frequency (5)
	7 iDEN, WiDEN mode	Returns comma-separated pass(0)/fail(1) test results for the relative power of the reference and offset channels, 4 values for iDEN and 6 values for WiDEN.  Reference channel – relative power pass/fail (returned as always PASSED). Reference channel – relative power pass/fail (returned as always PASSED) (duplicate of above). Lower offset channel of offset A– relative power pass/fail. Upper offset channel of offset A– relative power pass/fail. Lower offset channel of offset B– relative power pass/fail. If the carrier is selected any options except 50 kHz outer, returns 0 (passed). (WiDEN mode only) Upper offset channel of offset B– relative power pass/fail. If the carrier is selected any options except 50 kHz outer, returns 0/Passed. (WiDEN mode only)
Total power reference	7 Basic, cdmaOne, cdma2000, W-CDMA mode	Returns 12 scalar values of the pass/fail (0 = passed, or 1 = failed) results determined by testing the absolute power limit of the center and offset frequencies (measured as total power in dB):  1. Upper adjacent chan center frequency 2. Lower adjacent chan center frequency 3. Negative offset frequency (1) 4. Positive offset frequency (1)  . . .  1. Negative offset frequency (5) 2. Positive offset frequency (5)

Measurement Type	n	Results Returned
Power spectral density reference	7 Basic, cdmaOne, cdma2000, W-CDMA mode	Returns 12 scalar values of the pass/fail (0 = passed, or 1 = failed) results determined by testing the absolute power limit of the center and offset frequencies (measured as power spectral density in dB):  1. Upper adjacent chan center frequency 2. Lower adjacent chan center frequency 3. Negative offset frequency (1) 4. Positive offset frequency (1)  . . .  1. Negative offset frequency (5) 2. Positive offset frequency (5)
Total power reference	8 Basic, cdmaOne, cdma2000, W-CDMA mode	Returns 12 scalar values of the pass/fail (0 = passed, or 1 = failed) results determined by testing the power limit relative to the center frequency (measured as total power spectral in dB):  1. Upper adjacent chan center frequency 2. Lower adjacent chan center frequency 3. Negative offset frequency (1) 4. Positive offset frequency (1)  . . .  1. Negative offset frequency (5) 2. Positive offset frequency (5)
Power spectral density reference	8 Basic, cdmaOne, cdma2000, W-CDMA mode	Returns 12 scalar values of the pass/fail (0 = passed, or 1 = failed) results determined by testing the power limit relative to the center frequency (measured as power spectral density in dB):  1. Upper adjacent chan center frequency 2. Lower adjacent chan center frequency 3. Negative offset frequency (1) 4. Positive offset frequency (1)  . . .  1. Negative offset frequency (5) 2. Positive offset frequency (5)
	N=8 iDEN, WiDEN mode	Returns a single pass(0)/fail(1) test result that reflects composite pas/fail results which is determined according to [:SENSE]:ACPR:OFFSet:TEST. This allows a quick way to determine if the test passed without the need to query several bits.

## Bit Error Rate Measurement

This tests for bit errors in the demodulated signal. You must be in the iDEN or WiDEN mode to use these commands. Use INSTRument:SElect to set the mode.

The general functionality of CONFigure, FETCh, MEASure, and READ are described at the beginning of this section. See the SENSE:BER commands for more measurement related commands.

**:CONFigure:BER**

**:INITiate:BER**

**:FETCh:BER[n]?**

**:READ:BER[n]?**

**:MEASure:BER[n]?**

History: Version A.03.00 or later

Front Panel

Access: **Measure, Bit Error Rate**

After the measurement is selected, press **Restore Meas Defaults** to restore factory defaults.

### Measurement Results Available

<b>n</b>	<b>Results Returned</b>
0 iDEN or WiDEN mode	Returns unprocessed I/Q trace data, as a series of comma-separated trace point values, in volts. The I values are listed first in each pair, using the 0 through even-indexed values. The Q values are the odd-indexed values.

<b>n</b>	<b>Results Returned</b>
n=1 (or not specified) iDEN mode	Returns these 18 comma-separated scalar results in the following order: <ol style="list-style-type: none"> <li>1. Total bit error rate (BER in %)</li> <li>2. Total number of bits tested</li> <li>3. Total number of bits failed</li> <li>4. Total number of frames tested</li> <li>5. Total number of frames attempted to find</li> <li>6. Current frame word found</li> <li>7. Bit error rate for current word</li> <li>8. Measured carrier frequency</li> <li>9. Calculated center frequency error</li> <li>10. Frequency span</li> <li>11. Average count</li> <li>12. EVM for first sub-channel</li> <li>13. EVM for second sub-channel</li> <li>14. EVM for third sub-channel</li> <li>15. EVM for fourth sub-channel</li> <li>16. Composite RMS EVM of all subchannels</li> <li>17. Residual BER</li> <li>18. Frame Erasure Rate FER</li> </ol>
n=1 (or not specified) WiDEN mode	Returns these 13 comma-separated scalar results in the following order: <ol style="list-style-type: none"> <li>1. Total bit error rate (BER in %) of composite carriers</li> <li>2. Total number of bits tested of composite carriers</li> <li>3. Total number of bits failed of composite carriers</li> <li>4. Total number of slots tested</li> <li>5. Total number of slots attempted to find</li> <li>6. Bit error rate for current word of composite carriers</li> <li>7. Measured composite carrier center frequency</li> <li>8. Calculated center frequency error of composite carriers</li> <li>9. Frequency span of composite carriers</li> <li>10. Composite RMS EVM of composite carriers</li> <li>11. Residual BER</li> <li>12. Slot Erasure Rate (SER)</li> <li>13. Pass/Fail of the test</li> </ol>
2 iDEN mode	Returns unprocessed frame I/Q data, as a data array of comma-separated trace point values, in volts.
2 WiDEN mode	Returns results for Carrier #0, as a data array of comma-separated values by following order: <ol style="list-style-type: none"> <li>1. Current slot word found</li> <li>2. Bit error rate for current word</li> <li>3. Composite RMS EVM of all subchannels</li> </ol>



n	Results Returned
3 WiDEN mode	<p>Returns results for Carrier #1, as a data array of comma-separated values by following order:</p> <ol style="list-style-type: none"> <li>1. Current slot word found. If this carrier is inactive, returns –999.</li> <li>2. Bit error rate for current word. If this carrier is inactive, returns –999.</li> <li>3. Composite RMS EVM of all subchannels. If this carrier is inactive, returns –999.</li> </ol>
4 WiDEN mode	<p>Returns results for Carrier #2, as a data array of comma-separated values by following order:</p> <ol style="list-style-type: none"> <li>1. Current slot word found. If this carrier is inactive, returns –999.</li> <li>2. Bit error rate for current word. If this carrier is inactive, returns –999.</li> <li>3. Composite RMS EVM of all subchannels. If this carrier is inactive, returns –999.</li> </ol>
5 iDEN mode	Returns the Max EVM of the subchannels.
5 WiDEN mode	<p>Returns results for Carrier #3, as a data array of comma-separated values by following order:</p> <ol style="list-style-type: none"> <li>1. Current slot word found. If this carrier is inactive, returns –999.</li> <li>2. Bit error rate for current word. If this carrier is inactive, returns –999.</li> <li>3. Composite RMS EVM of all subchannels. If this carrier is inactive, returns –999.</li> </ol>
6 <sup>a</sup> iDEN mode	Returns the results of a PvT test. 1 = Pass and 0 = Fail, one results for each frame tested. For example, if Frame Count is set to 16, there are 16 comma-separated 0 s or 1 s.
6 WiDEN mode actual carrier config is 25 kHz	<p>Returns the Max EVM of the subchannels, as a data array of comma-separated values by the following order:</p> <ol style="list-style-type: none"> <li>1. EVM for the first sub-channel</li> <li>2. EVM for the second sub-channel</li> <li>3. EVM for the third sub-channel</li> <li>4. EVM for the fourth sub-channel</li> </ol>
6 WiDEN mode actual carrier config is any other than 25 kHz	<p>Returns the Max EVM of the each carrier, as a 4-element data array of comma-separated values by the following order:</p> <ol style="list-style-type: none"> <li>1. EVM for the Carrier #0.</li> <li>2. EVM for the Carrier #1. If the carrier is inactive (at the 50 kHz outer config), returns –999.</li> <li>3. EVM for the Carrier #2. If the carrier is inactive (at the 50 kHz, or 50 kHz outer config), returns –999.</li> <li>4. EVM for the Carrier #3. If the carrier is inactive (at the 50 kHz or 75 kHz config), returns –999.</li> </ol>

n	Results Returned
7 iDEN mode	Returns the points in microseconds that either fail the power mask or are closest to the power mask. One result for each frame tested. If the PvT test is pass, the point that has the smallest margin is returned. If the PvT test is fail, the first point that fails the power mask is returned. For example, Frame Count is set to 4, and the 3rd frame fails the mask at 720 $\mu$ s, the other frames pass and have the smallest margin at 150 $\mu$ s, 200 $\mu$ s, and 630 $\mu$ s respectful. Then the results returned will be 1.5e2, 2.0e2, 7.2e2, 6.3e2.
7 WiDEN mode	Returns the result of PvT test for the composite waveform (trace data preceding and following the SGC region of the trace) and for the MIN/MAX waveform of carrier #0 through #3 in the SGC trace region. 1 = Pass and 0 = Fail, one result for each slot tested. For example, if slot count is set to 16, there are 16 comma-separated 0s or 1s.
8 iDEN mode	Returns the margin (in dB) of the PvT test. One result for each frame tested. Refer to the example above, the 3rd frame fails the mask at 720 $\mu$ s with -3.2 dB margin (3.2 dB above the limit), the other frames have the smallest margin at 150 $\mu$ s with 3.5 dB margin, 200 $\mu$ s with 2.7 dB margin, 630 $\mu$ s with 3.1 dB margin, 150 $\mu$ s with 3.5 dB margin respectively. Then the results returned will be 3.5, 2.7, -3.2, 3.1.
8 WiDEN mode	Returns the points in microseconds that either fail the power mask or are closest to the power mask for the composite waveform (trace data preceding and following the SGC region of the trace) and for the MIN/MAX waveform of carrier #0 through #3 in the SGC trace region. One result for each slot tested. If the PvT test is pass, the point that has the smallest margin is returned. If the PvT test is fail, the first point that fails the power mask is returned. For example, Slot Count is set to 4, and the 3rd slot fails the mask at 720 us, the other slots pass and have the smallest margin at 150 us, 200 us, and 630 us respectively, then the results returned will be 1.5e2, 2.0e2, 7.2e2, 6.3e2.
9 WiDEN mode	Returns the margin of PvT test for the composite waveform (trace data preceding and following the SGC region of the trace) and for the MIN/MAX waveform of carrier #0 through #3 in the SGC trace region. One result for each slot tested. Refer to the example of n=8, the 3rd slot fails the mask at 720 us with -3.2 dB margin (3.2 dB over the limit), the other slots have the smallest margin at 150 us with 3.5 dB margin, 200 us with 2.7 dB margin, 630 us with 3.1 dB margin, respectively. Then the results returned will be 3.5, 2.7, -3.2, 3.1.
10 WiDEN mode	Returns an array of 4 elements denoting the relative power of each carrier (#0,#1, #2 and #3) for the latest slot. If this carrier is inactive, returns -999.
11 WiDEN mode	Returns a single pass(0)/fail(1) test result that reflects the “OR” of all individual pass/fail bits (see n=1 and n=7). This allows a quick way to determine if the test passed without the need to query several bits.

- a. Sub-opcode 6 tell pass/fail, sub-opcode 7 tells where in time, sub-opcode tells by how much. Sub-opcodes 6, 7, and 8 should be used together to retrieve PvT test results.

## Occupied Bandwidth Measurement

This measures the bandwidth of the carrier signal in the occupied part of the channel. You must be in the PDC, iDEN (E4406A only), WiDEN (E4406A only), cdma2000, W-CDMA, or 1xEV-DO mode to use these commands. Use INSTRument:SElect to set the mode.

The general functionality of CONFigure, FETCh, MEASure, and READ are described at the beginning of this section. See the SENSE:OBW commands for more measurement related commands.

**:CONFigure:OBW**

**:INITiate:OBW**

**:FETCh:OBW[n]?**

**:READ:OBW[n]?**

**:MEASure:OBW[n]?**

History: E4406A:  
 Version A.02.00 or later  
 Widen is available on Version A.07.05 or later

Front Panel

Access: **Measure, Occupied BW**

After the measurement is selected, press **Restore Meas Defaults** to restore factory defaults.

### Measurement results available

<b>n</b>	<b>Results Returned</b>
0	Returns unprocessed I/Q trace data, as a data array of trace point values, in volts.
0 WiDEN mode E4406A	Returns unprocessed I/Q trace data, as a series of comma-separated trace points, in volts. The I values are listed first in each pair, using the 0 through even-indexed values. The Q values are the odd-indexed values.
1 (default) cdma2000, W-CDMA mode	Returns scalar results, in the following order: <ol style="list-style-type: none"> <li>1. Occupied bandwidth - Hz</li> <li>2. Absolute Carrier Power - dBm</li> </ol>
1 (default) PDC	Returns scalar results, in the following order: <ol style="list-style-type: none"> <li>1. Occupied bandwidth - kHz</li> <li>2. Absolute Carrier Power - dBm</li> </ol>

<b>n</b>	<b>Results Returned</b>
1 (default) 1xEV-DO mode	Returns scalar results, in the following order: 1. Occupied bandwidth - Hz 2. Absolute Carrier Power - dBm 3. Span - Hz 4. Spectrum Trace Points - points 5. Res BW - Hz
1 (default) iDEN mode E4406A	Returns 7 comma-separated scalar results, in the following order. 1. Bandwidth for specified power percentage (Hz) 2. Absolute power of occupied bandwidth (dBm) 3. PSD of occupied bandwidth (dB) 4. Power percentage 5. Measured carrier frequency after centroid. (Hz) 6. Frequency span (Hz) 7. Average count
1 (default) WiDEN mode E4406A	Returns 8 comma-separated scalar results, in the following order. 1. Bandwidth for specified power percentage (Hz) 2. Absolute power of occupied bandwidth (dBm) 3. PSD of occupied bandwidth (dB) 4. Power percentage 5. Measured carrier frequency after centroid. (Hz) 6. Frequency span (Hz) 7. Average count 8. Delta Freq (computed as Fcentroid – Fcenter)
2 PDC, cdma2000, W-CDMA, 1xEV-DO mode	Returns the frequency-domain spectrum trace (data array) for the entire frequency range being measured.
n2, spectrum display only iDEN or WiDEN mode E4406A	Returns the frequency-domain spectrum trace (data array) for the entire frequency range being measured.
3 WiDEN mode E4406A	Returns a single pass(0)/fail(1) test result. This allows a quick way to determine if the test passed without the need to parse several values.

## Power vs. Time Measurement

For E4406A this measures the average power during the “useful part” of the burst comparing the power ramp to required timing mask. You must be in EDGE, GSM, 1xEV-DO or Service mode to use these commands. Use INSTRument:SElect to set the mode.

The general functionality of CONFigure, FETCh, MEASure, and READ are described at the beginning of this section. See the SENSE:PVTime commands for more measurement related commands.

**:CONFigure:PVTime**

**:INITiate:PVTime**

**:FETCh:PVTime [n] ?**

**:READ:PVTime [n] ?**

**:MEASure:PVTime [n] ?**

Front Panel

Access: **Measure, Power vs Time**

After the measurement is selected, press **Restore Meas Defaults** to restore factory defaults.

History: Modified in version A.05.00.

### Measurement Results Available

<b>n</b>	<b>Results Returned</b>
0	Returns unprocessed I/Q trace data, as a series of trace point values, in volts. The I values are listed first in each pair, using the 0 through even-indexed values. The Q values are the odd-indexed values.

n	Results Returned
n=1 (or not specified)	<p>Returns the following scalar results:</p> <ol style="list-style-type: none"> <li>1. <b>Sample time</b> is a floating point number that represents the time between samples when using the trace queries (n=0,2,etc.).</li> <li>2. <b>Power of single burst</b> is the mean power (in dBm) across the useful part of the selected burst in the most recently acquired data, or in the last data acquired at the end of a set of averages. If averaging is on, the power is for the last burst.</li> <li>3. <b>Power averaged</b> is the power (in dBm) of N averaged bursts, if averaging is on. The power is averaged across the useful part of the burst. Average <i>m</i> is a single burst from the acquired trace. If there are multiple bursts in the acquired trace, only one burst is used for average <i>m</i>. This means that N traces are acquired to make the complete average. If averaging is off, the value of <b>power averaged</b> is the same as the <b>power single burst</b> value.</li> <li>4. <b>Number of samples</b> is the number of data points in the captured signal. This number is useful when performing a query on the signal (i.e. when n=0,2,etc.).</li> <li>5. <b>Start point of the useful part of the burst</b> is the index of the data point at the start of the useful part of the burst</li> <li>6. <b>Stop point of the useful part of the burst</b> is the index of the data point at the end of the useful part of the burst</li> <li>7. Index of the data point where <math>T_0</math> occurred, where <math>T_0</math> is the time point of the transition from bit 13 to bit 14 of the midamble training sequence.</li> <li>8. <b>Burst width of the useful part of the burst</b> is the width of the burst measured at -3 dB below the mean power in the useful part of the burst.</li> <li>9. <b>Maximum value</b> is the maximum value of the most recently acquired data (in dBm).</li> <li>10. <b>Minimum value</b> is the minimum value of the most recently acquired data (in dBm).</li> <li>11. <b>Burst search threshold</b> is the value (in dBm) of the threshold where a valid burst is identified, after the data has been acquired.</li> <li>12. <b>IQ point delta</b> is the number of data points offset that are internally applied to the useful data in traces <math>n=2,3,4</math>. You must apply this correction value to find the actual location of the <b>Start, Stop</b>, or <math>T_0</math> values.</li> </ol>

n	Results Returned
<p>n=1 (or not specified) 1xEV-DO or W-CDMA mode</p>	<p>Returns the following scalar results:</p> <ol style="list-style-type: none"> <li>1. <b>Sample time</b> is a floating point number that represents the time between samples when using the trace queries (where n = 0, 2, etc.).</li> <li>2. <b>Power of single burst</b> is the mean power (in dBm) across the useful part of the selected burst in the most recently acquired data, or in the last data acquired at the end of a set of averages. If averaging is on, the power is for the last burst.</li> <li>3. <b>Power averaged</b> is the power (in dBm) of N averaged bursts, if averaging is on. The power is averaged across the useful part of the burst. Average m is a single burst from the acquired trace. If there are multiple bursts in the acquired trace, only one burst is used for average m. This means that N traces are acquired to make the complete average. If averaging is off, the value of <b>power averaged</b> is the same as the <b>power single burst</b> value.</li> <li>4. <b>Number of samples (N)</b> is the number of data points in the captured signal. This number is useful when performing a query on the signal (i.e. when n = 0, 2, etc.).</li> <li>5. <b>Start point of the useful part of the burst</b> is the index of the data point at the start of the useful part of the burst</li> <li>6. <b>Stop point of the useful part of the burst</b> is the index of the data point at the end of the useful part of the burst</li> <li>7. Index of the data point where T<sub>0</sub> occurred.</li> <li>8. <b>Burst width of the useful part of the burst</b> is the width of the burst measured at -3 dB below the mean power in the useful part of the burst.</li> <li>9. <b>Maximum value</b> is the maximum value of the most recently acquired data (in dBm).</li> <li>10. <b>Minimum value</b> is the minimum value of the most recently acquired data (in dBm).</li> <li>11. <b>Burst search threshold</b> is the value (in dBm) of the threshold where a valid burst is identified, after the data has been acquired.</li> <li>12. <b>Averaged number (N)</b> is used to average the measurement results.</li> <li>13. <b>First position in index to exceed the limit (N)</b> is ?</li> <li>14. Reserved for future use, returns -999.0.</li> <li>15. Reserved for future use, returns -999.0.</li> <li>16. Reserved for future use, returns -999.0.</li> <li>17. <b>Absolute power in the region A (dBm)</b></li> <li>18. <b>Absolute power in the region B (dBm)</b></li> <li>19. <b>Absolute power in the region C (dBm)</b></li> <li>20. <b>Absolute power in the region D (dBm)</b></li> <li>21. <b>Absolute power in the region E (dBm)</b></li> <li>22. <b>Relative power in the region A (dB)</b></li> <li>23. <b>Relative power in the region B (dB)</b></li> <li>24. <b>Relative power in the region C (dB)</b></li> <li>25. <b>Relative power in the region D (dB)</b></li> </ol>

n	Results Returned
n=1 (or not specified) (cont.)  1xEV-DO or W-CDMA mode	26. <b>Relative power in the region E (dB)</b> 27. <b>Maximum absolute power in the region A (dBm)</b> 28. <b>Maximum absolute power in the region B (dBm)</b> 29. <b>Maximum absolute power in the region C (dBm)</b> 30. <b>Maximum absolute power in the region D (dBm)</b> 31. <b>Maximum absolute power in the region E (dBm)</b> 32. <b>Maximum relative power in the region A (dB)</b> 33. <b>Maximum relative power in the region B (dB)</b> 34. <b>Maximum relative power in the region C (dB)</b> 35. <b>Maximum relative power in the region D (dB)</b> 36. <b>Maximum relative power in the region E (dB)</b> 37. <b>Minimum absolute power in the region A (dBm)</b> 38. <b>Minimum absolute power in the region B (dBm)</b> 39. <b>Minimum absolute power in the region C (dBm)</b> 40. <b>Minimum absolute power in the region D (dBm)</b> 41. <b>Minimum absolute power in the region E (dBm)</b> 42. <b>Minimum relative power in the region A (dB)</b> 43. <b>Minimum relative power in the region B (dB)</b> 44. <b>Minimum relative power in the region C (dB)</b> 45. <b>Minimum relative power in the region D (dB)</b> 46. <b>Minimum relative power in the region E (dB)</b>
n=1 (or not specified)  iDEN or WiDEN mode	Returns the following comma-separated scalar results:  1. <b>Avg Transmit Power</b> is the mean power (in dBm) across the modulated symbols. 2. <b>Sampling Frequency</b> 3. <b>Number of samples</b> is the number of data points in the captured signal. This number is useful when performing a query on the signal (i.e. when n=0,2,etc.). 4. <b>Resolution Bandwidth</b> is the IF Bandwidth or data acquisition. 5. <b>Point index of the peak of first modulated symbol</b> 6. <b>Point index of the peak of last modulated symbol</b> 7. <b>First data point that fail the limit test, in time (μsec)</b> . If pass, -999 is returned. 8. <b>Power difference between the signal and the limit at the first fail point, in dB</b> . If pass, -999 is returned. 9. <b>Data point that has the smallest margin to the masks, in time (μsec)</b> . If fail, -999 is returned. 10. <b>The smallest margin, in dB, of the signal to the masks</b> . If fail, -999 is returned.
2	Returns trace point values of the entire captured I/Q trace data. These data points are floating point numbers representing the power of the signal (in dBm). There are N data points, where N is the <b>number of samples</b> . The period between the samples is defined by the <b>sample time</b> .



<b>n</b>	<b>Results Returned</b>
2 WiDEN mode	Returns a single pass(0)/fail(1) test result. This allows a quick way to determine if the test passed without the need to parse through several values.
3	Returns data points representing the upper mask (in dBm).
4	Returns data points representing the lower mask (in dBm).
6 W-CDMA mode	Returns 5 comma-separated scalar values of the pass/fail (0.0 = passed, or 1.0 = failed) results determined by testing the upper mask.
7 W-CDMA mode	Returns 5 comma-separated scalar values of the pass/fail (0.0 = passed, or 1.0 = failed) results determined by testing the lower mask:
7 EDGE, GSM, Service mode (E4406A only)	Returns power level values for the 8 slots in the current frame (in dBm).
8, only available when averaging is set to both maximum and minimum	Returns trace point values of the minimum waveform data. These data points are floating point numbers representing the power of the signal (in dBm). There are N data points, where N is the <b>number of samples</b> . The period between the samples is defined by the <b>sample time</b> .  Use SENSE:PVT:AVERAge:TYPE MXMinimum to set averaging to max and min. Use n=2 to return the corresponding maximum trace.

## MotoTalk Average Power (MT Avg Pwr) Measurement

This measures the average transmit power of normal (traffic) bursts in the time domain. You must select the appropriate mode using INSTRument:SElect, to use these commands.

The general functionality of CONFigure, FETCh, MEASure, and READ are described at the beginning of this section. See the SENSE:APOWer commands for more measurement related commands.

**:CONFigure:APOWer**

**:FETCh:APOWer [n] ?**

**:READ:APOWer [n] ?**

**:MEASure:APOWer [n] ?**

Front Panel

Access: **Measure, MT Avg Pwr**

After the measurement is selected, press **Restore Meas Defaults** to restore factory defaults.

### Measurement Results Available

n	Results Returned
0	Returns unprocessed I/Q trace data, as a series of comma-separated trace points, in volts. The I values are listed first in each pair, using the 0 through even-indexed values. The Q values are the odd-indexed values.  Residual BER is the BER of the found frames (not including the dropped frames). Frame Erasure Rate (FER) = (frames dropped / frames tested) * 100.
not specified or n=1	Returns the following comma-separated scalar results:  <ol style="list-style-type: none"> <li><b>Average power of gated signal.</b> If Meas Method is Burst, -999 will be returned.</li> <li><b>Average of the average power of bursts</b></li> <li><b>Max average power of bursts</b></li> <li><b>Min average power of bursts is</b></li> <li><b>Number of bursts averaged</b></li> </ol>
2	Returns the unprocessed trace data as a series of comma-separated trace points, in dBm.
3	Returns the average power of all bursts as a series of comma-separated numbers, in dBm.

## MotoTalk Transient EVM (MT Trans EVM) Measurement

This measures the EVM (hopping or non-hopping) of MotoTalk normal (traffic) bursts. You must select the appropriate mode using INSTRUMENT:SElect, to use these commands.

The general functionality of CONFigure, FETCh, MEASure, and READ are described at the beginning of this section. See the SENSE:TEVM commands for more measurement related commands.

**:CONFigure:TEVM**

**:FETCh:TEVM[n]?**

**:READ:TEVM[n]?**

**:MEASure:TEVM[n]?**

Front Panel

Access: **Measure, MT Trans EVM**

After the measurement is selected, press **Restore Meas Defaults** to restore factory defaults.

### Measurement Results Available

<b>n</b>	<b>Results Returned</b>
0	Returns unprocessed I/Q trace data, as a data array of trace point values, in volts.
not specified or n=1	Returns the following comma-separated scalar results: <ol style="list-style-type: none"> <li>1. <b>Average EVM of all traffic bursts</b></li> <li>2. <b>Max EVM of all traffic bursts</b> – a floating point number (in percent) of highest EVM over the entire measurement area.</li> <li>3. <b>Min EVM of all traffic bursts</b> – a floating point number (in percent) of lowest EVM over the entire measurement area.</li> <li>4. <b>Number of bursts averaged</b></li> <li>5. <b>Carrier offset</b></li> </ol>
2	Returns the EVM of all traffic bursts as a series of comma-separated numbers, in percentage.

## Spectrum (Frequency Domain) Measurement

This measures the amplitude of your input signal with respect to the frequency. It provides spectrum analysis capability using FFT (fast Fourier transform) measurement techniques. You must select the appropriate mode using INSTRument:SElect, to use these commands.

The general functionality of CONFigure, FETCh, MEASure, and READ are described at the beginning of this section. See the SENSE:SPECTrum commands for more measurement related commands.

**:CONFigure:SPECTrum**

**:FETCh:SPECTrum[n]?**

**:READ:SPECTrum[n]?**

**:MEASure:SPECTrum[n]?**

Front Panel

Access: **Measure, Spectrum (Freq Domain)**

After the measurement is selected, press **Restore Meas Defaults** to restore factory defaults.

### Measurement Results Available

<b>n</b>	<b>Results Returned</b>
0	Returns unprocessed I/Q trace data, as a series of comma-separated trace points, in volts. The I values are listed first in each pair, using the 0 through even-indexed values. The Q values are the odd-indexed values.

<b>n</b>	<b>Results Returned</b>
not specified or n=1	<p>Returns the following comma-separated scalar results:</p> <ol style="list-style-type: none"> <li>1. <b>FFT peak</b> is the FFT peak amplitude.</li> <li>2. <b>FFT frequency</b> is the FFT frequency of the peak amplitude.</li> <li>3. <b>FFT points</b> is the Number of points in the FFT spectrum.</li> <li>4. <b>First FFT frequency</b> is the frequency of the first FFT point of the spectrum.</li> <li>5. <b>FFT spacing</b> is the frequency spacing between the FFT points of the spectrum.</li> <li>6. <b>Time domain points</b> is the number of points in the time domain trace used for the FFT.</li> <li>7. <b>First time point</b> is the time of the first time domain point, where time zero is the trigger event.</li> <li>8. <b>Time spacing</b> is the time spacing between the time domain points.</li> <li>9. <b>Time domain</b> returns a 1, if time domain is complex (I/Q), or 0 if it is real. (raw ADC samples)</li> <li>10. <b>Scan time</b> is the total scan time of the time domain trace used for the FFT. The total scan time = (time spacing) X (time domain points – 1)</li> <li>11. <b>Current average count</b> is the current number of data measurements that have already been combined, in the averaging calculation.</li> </ol>
2, <b>Service mode only</b>	Returns the trace data of the log-magnitude versus time. (That is, the RF envelope.)
3	Returns the I and Q trace data. It is represented by I and Q pairs (in volts) versus time.
4	Returns spectrum trace data. That is, the trace of log-magnitude versus frequency. (The trace is computed using a FFT.)
5, <b>Service mode only</b>	Returns the averaged trace data of log-magnitude versus time. (That is, the RF envelope.)
6	Not used.
7	Returns the averaged spectrum trace data. That is, the trace of the averaged log-magnitude versus frequency.
8	Not used.
9, <b>Service mode only</b>	Returns a trace containing the shape of the FFT window.
10, <b>Service mode only</b>	Returns trace data of the phase of the FFT versus frequency.

## Waveform (Time Domain) Measurement

This measures the power in your input signal with respect to time and is equivalent to zero-span operation in a traditional spectrum analyzer. You must select the appropriate mode using INSTRUMENT:SElect, to use these commands.

The general functionality of CONFigure, FETCh, MEASure, and READ are described at the beginning of this section. See the SENSE:WAVEform commands for more measurement related commands.

**:CONFigure:WAVEform**

**:FETCh:WAVEform[n]?**

**:READ:WAVEform[n]?**

**:MEASure:WAVEform[n]?**

Front Panel

Access: **Measure, Waveform (Time Domain)**

After the measurement is selected, press **Restore Meas Defaults** to restore factory defaults.

### Measurement Results Available

<b>n</b>	<b>Results Returned</b>
0	Returns unprocessed I/Q trace data, as a series of comma-separated trace points, in volts. The I values are listed first in each pair, using the 0 through even-indexed values. The Q values are the odd-indexed values.

<b>n</b>	<b>Results Returned</b>
not specified or n=1	<p>Returns the following comma-separated scalar results:</p> <ol style="list-style-type: none"> <li>1. <b>Sample time</b> is a floating point number representing the time between samples when using the trace queries (n=0,2,etc).</li> <li>2. <b>Mean power</b> is the mean power (in dBm). This is either the power across the entire trace, or the power between markers if the markers are enabled. If averaging is on, the power is for the latest acquisition.</li> <li>3. <b>Mean power averaged</b> is the power (in dBm) for N averages, if averaging is on. This is either the power across the entire trace, or the power between markers if the markers are enabled. If averaging is on, the power is for the latest acquisition. If averaging is off, the value of the mean power averaged is the same as the value of the mean power.</li> <li>4. <b>Number of samples</b> is the number of data points in the captured signal. This number is useful when performing a query on the signal (i.e. when n=0,2,etc.).</li> <li>5. <b>Peak-to-mean ratio</b> has units of dB. This is the ratio of the maximum signal level to the mean power. Valid values are only obtained with averaging turned off. If averaging is on, the peak-to-mean ratio is calculated using the highest peak value, rather than the displayed average peak value.</li> <li>6. <b>Maximum value</b> is the maximum of the most recently acquired data (in dBm).</li> <li>7. <b>Minimum value</b> is the minimum of the most recently acquired data (in dBm).</li> </ol>
2	<p>Returns comma-separated trace points of the entire captured trace data. These data points are floating point numbers representing the power of the signal (in dBm). There are N data points, where N is the <b>number of samples</b>. The period between the samples is defined by the <b>sample time</b>.</p>

## READ Subsystem

**:READ: <measurement> [n] ?**

The READ? commands are used with several other commands and are documented in the section on the “[MEASure Group of Commands](#)” on [page 138](#).



---

## SENSe Subsystem

Sets the instrument state parameters so that you can measure the input signal.

### Adjacent Channel Power Measurement

Commands for querying the adjacent channel power measurement results and for setting to the default values are found in the “[MEASure Group of Commands](#)” on page 138. The equivalent front panel keys for the parameters described in the following commands, are found under the **Meas Setup** key, after the **ACP** measurement has been selected from the **MEASURE** key menu.

#### Adjacent Channel Power—Average Count

```
[ :SENSe ] :ACP:AVERAge:COUNT <integer>
```

```
[ :SENSe ] :ACP:AVERAge:COUNT?
```

Set the number of data acquisitions that will be averaged. After the specified number of average counts, the average mode (termination control) setting determines the average action.

Factory Preset

and \*RST:      10, for cdma2000, W-CDMA mode  
                  20, for Basic, cdmaOne, iDEN, WiDEN mode

Range:            1 to 10,000

Remarks:        Use INSTRument:SElect to set the mode.

#### Adjacent Channel Power—Averaging State

```
[ :SENSe ] :ACP:AVERAge [ :STATe ] OFF | ON | 0 | 1
```

```
[ :SENSe ] :ACP:AVERAge [ :STATe ] ?
```

Turn average on or off.

Factory Preset

and \*RST:      On  
                  Off, for iDEN, WiDEN mode

Remarks:        Use INSTRument:SElect to set the mode.

## Adjacent Channel Power—Averaging Termination Control

```
[ :SENSe ] :ACP:AVERAge:TCONtrol EXPONential | REPeat
```

```
[ :SENSe ] :ACP:AVERAge:TCONtrol?
```

Select the type of termination control used for averaging. This determines the averaging action after the specified number of data acquisitions (average count) is reached.

Exponential – Each successive data acquisition after the average count is reached, is exponentially weighted and combined with the existing average.

Repeat – After reaching the average count, the averaging is reset and a new average is started.

Factory Preset

and \*RST: Repeat, for basic, cdmaOne, cdma2000, W-CDMA mode  
Exponential, for NADC, PDC, iDEN, WiDEN mode

Remarks: Use INSTRument:SElect to set the mode.

## Adjacent Channel Power—Carrier Channel Integration BW

*Basic, iDEN, WiDEN mode (E4406A)*

```
[ :SENSe ] :ACP:BANDwidth | BWIDth:INTEgration <freq>
```

```
[ :SENSe ] :ACP:BANDwidth | BWIDth:INTEgration?
```

*cdma2000, W-CDMA mode*

```
[ :SENSe ] :ACP:BANDwidth[n] | BWIDth[n]:INTEgration <freq>
```

```
[ :SENSe ] :ACP:BANDwidth[n] | BWIDth[n]:INTEgration?
```

*cdmaOne mode*

```
[ :SENSe ] :ACP:BANDwidth[n] | BWIDth[n]:INTEgration[m] <freq>
```

```
[ :SENSe ] :ACP:BANDwidth[n] | BWIDth[n]:INTEgration[m]?
```

Set the Integration bandwidth that will be used for the main (carrier) channel.

BANDwidth[n] |

BWIDth[n]: m=1 is base station and 2 is mobiles. The default is base station (1).

INTEgration[n]: m=1 is cellular bands and 2 is pcs bands. The default is cellular.

Example: *WiDEN mode (E4406A)*

```
ACP:BAND:INT 93 kHz
```

Factory Preset:

Mode	Format (Modulation Standard)		
<b>Basic</b> (E4406A)	1.23 MHz		
<b>cdmaOne</b>	1.23 MHz		
<b>iDEN</b> (E4406A)	18 kHz		
<b>cdma2000</b>	1.23 MHz		
<b>W-CDMA</b>	3.84 MHz		

Factory Preset: *WiDEN mode* (E4406A)

Carrier Configuration Setting	Default
Auto	Actual value depends on detected carrier configuration and cannot be changed.
25 kHz	18.0 kHz
50 kHz	43.0 kHz
50 kHz outer	93.0 kHz
75 kHz	68.0 kHz
100 kHz	93.0 kHz

Range: 300 Hz to 20 MHz for Basic (E4406A), cdmaOne, cdma2000, or W-CDMA mode

1 kHz to 5 MHz for iDEN, WiDEN (E4406A)

Default Unit: Hz

Remarks: With measurement type set at (TPR) total power reference, 1.40 MHz is sometimes used. Using 1.23 MHz will give a power that is very nearly identical to the 1.40 MHz value, and using 1.23 MHz will also yield the correct power spectral density with measurement type set at (PSD) reference. However, a setting of 1.40 MHz will not give the correct results with measurement type set at PSD reference.

For E4406A WiDEN mode, if you have set the Carrier Config ([:SENSe]:RADio:CARRier[:TYPE]) to AUTO, the value is set to the default value described in “[Factory Preset:](#)” above according to the actual carrier config (you can see detected carrier configuration by sending [:SENSe]:RADio:CARRier[:TYPE]:ACTual?) You can not change this value. Even if the you set this value using SCPI,

it is ignored and the default value is used.

For E4406A you must be in Basic, cdmaOne, cdma2000, W-CDMA, iDEN, or WiDEN mode to use this command. Use INSTRument:SElect to set the mode.

Front Panel  
Access:

**Meas Setup**

## Adjacent Channel Power—Absolute Amplitude Limits

*iDEN mode (E4406A)*

```
[ :SENSE ] :ACP:OFFSet:ABSolute <power>
```

```
[ :SENSE ] :ACP:OFFSet:ABSolute?
```

*WiDEN mode (E4406A)*

```
[ :SENSE ] :ACP:OFFSet:LIST:ABSolute <power>, <power>
```

```
[ :SENSE ] :ACP:OFFSet:LIST:ABSolute?
```

*Basic (E4406A), cdmaOne mode*

```
[ :SENSE ] :ACP:OFFSet:LIST:ABSolute  
<power>, <power>, <power>, <power>, <power>
```

```
[ :SENSE ] :ACP:OFFSet:LIST:ABSolute?
```

*cdma2000, W-CDMA mode*

```
[ :SENSE ] :ACP:OFFSet [n] :LIST:ABSolute  
<power>, <power>, <power>, <power>, <power>
```

```
[ :SENSE ] :ACP:OFFSet [n] :LIST:ABSolute?
```

Sets the absolute amplitude levels to test against for each of the custom offsets. The list must contain five (5) entries (two (2) entries for WiDEN). If there is more than one offset, the offset closest to the carrier channel is the first one in the list.

[ :SENSE ] :ACP:OFFSet[n]:LIST[m]:TEST selects the type of testing to be done at each offset.

You can turn off (not use) specific offsets with the [ :SENSE ] :ACP:OFFSet[n]:LIST:STATe command.

The query returns the five (5) sets of the real numbers that are the current absolute amplitude test limits.

Offset[n]            n=1 is base station and 2 is mobiles. The default is base station (1).

List[n]             m=1 is cellular bands and 2 is pcs bands. The default is cellular.

Factory Preset: *WiDEN mode (E4406A)*

Carrier Configuration Setting	Default	
	A	B
Auto	Actual value depends on detected carrier configuration and cannot be changed.	
25 kHz	0.0 dBm	N/A

Carrier Configuration Setting	Default	
	A	B
50 kHz	0.0 dBm	N/A
50 kHz outer	0.0 dBm	0.0 dBm
75 kHz	0.0 dBm	N/A
100 kHz	0.0 dBm	N/A

Factory Preset:

Mode	Variant	Offset A	Offset B	Offset C	Offset D	Offset E
<b>Basic</b> (E4406A)		0 dBm	0 dBm	0 dBm	0 dBm	0 dBm
<b>cdmaOne</b>	BS cellular	0 dBm	0 dBm	0 dBm	0 dBm	0 dBm
	BS pcs	0 dBm	-13 dBm	-13 dBm	0 dBm	0 dBm
	MS cellular	0 dBm	0 dBm	0 dBm	0 dBm	0 dBm
	MS pcs	0 dBm	-13 dBm	-13 dBm	0 dBm	0 dBm
<b>cdma2000</b>		50 dBm	50 dBm	50 dBm	50 dBm	50 dBm
<b>W-CDMA</b>		50 dBm	50 dBm	50 dBm	50 dBm	50 dBm
<b>iDEN</b> (E4406A)		0 dBm	n/a	n/a	n/a	n/a

Range: -200.0 dBm to 50.0 dBm

Default Unit: dBm

Remarks: For E4406A you must be in Basic, cdmaOne, cdma2000, W-CDMA, WiDEN, or iDEN mode to use this command. Use INSTRUMENT:SElect to set the mode.

For E4406A WiDEN mode:

- When you set these values remotely, the position of each value in the list sent corresponds to the offset. Missing values are not permitted. For example, if you want to change the value of offset “B”, you must send all values up to 2.
- The default values are set according to [:SENSe]:RADio:CARRier[:TYPE]:ACTual? setting as defined in Defaults table shown above.
- If you have set Carrier Config ([:SENSe]:RADio:CARRier[:TYPE]) to AUTO, the value is set to the default value described in “Factory

**Preset:**” above according to the actual carrier configuration detected (you can see detected carrier configuration by sending [:SENSe]:RADio:CARRier[:TYPE]:ACTual?) You can not change this value. Even if the you set this value using SCPI, it is ignored and the default value is used.

- You must always send two <freq> values regardless of the [:SENSe]:RADio:CARRier[:TYPE] setting. The first value is for offset “A” and the second is for offset “B”. Note that the offset “B” value is only used when [:SENSe]:RADio:CARRier[:TYPE]? returns O50, but two values are always needed when the you send this command. If you send only one value, “-109 Missing parameter” is returned.
- When sending this query form of this command, the second element of the responded array is always present but only used when [:SENSe]:RADio:CARRier[:TYPE]:ACTual? returns O50.

Front Panel

Access:

**Meas Setup, Ofs & Limits**

## Adjacent Channel Power—Define Resolution Bandwidth List

*iDEN mode (E4406A)*

```
[:SENSe]:ACP:OFFSet:BANDwidth|BWIDth <res_bw>
```

```
[:SENSe]:ACP:OFFSet:BANDwidth|BWIDth?
```

*WiDEN mode (E4406A)*

```
[:SENSe]:ACP:OFFSet:BANDwidth|BWIDth <res_bw>,<res_bw>
```

```
[:SENSe]:ACP:OFFSet:BANDwidth|BWIDth?
```

*Basic mode (E4406A)*

```
[:SENSe]:ACP:OFFSet:LIST:BANDwidth|BWIDth  
<res_bw>,<res_bw>,<res_bw>,<res_bw>,<res_bw>
```

```
[:SENSe]:ACP:OFFSet:LIST:BANDwidth|BWIDth?
```

*cdma2000, W-CDMA mode*

```
[:SENSe]:ACP:OFFSet [n]:LIST:BANDwidth|BWIDth  
<res_bw>,<res_bw>,<res_bw>,<res_bw>,<res_bw>
```

```
[:SENSe]:ACP:OFFSet [n]:LIST:BANDwidth|BWIDth?
```

*cdmaOne mode*

```
[[:SENSe]:ACP:OFFSet [n]:LIST[n]:BANDwidth|BWIDth
<res_bw>, <res_bw>, <res_bw>, <res_bw>, <res_bw>
```

```
[[:SENSe]:ACP:OFFSet [n]:LIST[n]:BANDwidth|BWIDth?
```

Define the custom resolution bandwidth(s) for the adjacent channel power testing. If there is more than one bandwidth, the list must contain five (5) entries. Each resolution bandwidth in the list corresponds to an offset frequency in the list defined by [:SENSe]:ACP:OFFSet[n]:LIST[n]:FREQUency]. You can turn off (not use) specific offsets with the [:SENSe]:ACP:OFFSet[n]:LIST[n]:STATe command.

Offset[n]            n=1 is base station and 2 is mobiles. The default is base station (1).

List[n]

*cdmaOne mode*    n=1 is cellular bands and 2 is pcs bands. The default is cellular.

*cdma2000 mode*   n=1 is SR1, 2 is SR3 DS, and 3 is SR3 MC. The default is SR1 (1).

*W-CDMA mode*    n=1 is ARIB, 2 is 3GPP, and 3 is Trial. The default is ARIB (1).

Example:            *WiDEN mode* (E4406A):

(Example #1)    When [:SENSe]:RADio:CARRier [:TYPE]:ACTual? returns I25, I50, I75, or I100, and you want to set the offset bandwidth of offset A to 20 kHz, send:  
ACP:OFFS:LIST:band 20e3, 10e3 (the second value can be arbitrary, but it is needed).

(Example #2)    When [:SENSe]:RADio:CARRier [:TYPE]:ACTual? returns O50, and you want to set the offset bandwidth of offset A and B to 20 kHz and 5 kHz respectively, send:  
ACP:OFFS:LIST:band 20e3, 5e3

State Saved:      Saved in Instrument State

Factory Preset:   *WiDEN mode* (E4406A)

Carrier Configuration Setting	Default	
	A	B
Auto	Actual value depends on detected carrier configuration and cannot be changed.	



Carrier Configuration Setting	Default	
	A	B
25 kHz	18.0 kHz	N/A
50 kHz	18.0 kHz	N/A
50 kHz outer	18.0 kHz	18.0 kHz
75 kHz	18.0 kHz	N/A
100 kHz	18.0 kHz	N/A

Factory Preset:

Mode	Variant	Offset A	Offset B	Offset C	Offset D	Offset E
<b>iDEN</b> (E4406A)		10 kHz	n/a	n/a	n/a	n/a
<b>Basic</b> (E4406A)		30 kHz	30 kHz	30 kHz	30 kHz	30 kHz
<b>cdmaOne</b>	BS cellular	30 kHz	30 kHz	30 kHz	30 kHz	30 kHz
	BS pcs	30 kHz	12.5 kHz	1 MHz	30 kHz	30 kHz
	MS cellular	30 kHz	30 kHz	30 kHz	30 kHz	30 kHz
	MS pcs	30 kHz	12.5 kHz	1 MHz	30 kHz	30 kHz
<b>cdma2000</b>		30 kHz	30 kHz	30 kHz	30 kHz	30 kHz
<b>W-CDMA</b>		3.84 MHz	3.84 MHz	3.84 MHz	3.84 MHz	3.84 MHz

Range: 300 Hz to 20 MHz for cdmaOne, Basic, cdma2000, W-CDMA mode

1 kHz to 5 MHz for iDEN mode (E4406A)

100 kHz to 20 MHz for WiDEN mode (E4406A)

Default Unit: Hz

Remarks: For E4406A you must be in Basic, cdmaOne, cdma2000, W-CDMA, WiDEN, or iDEN mode to use this command. Use INSTRUMENT:SElect to set the mode.

For E4406A WiDEN mode:

- When you set these values remotely, the position of each value in the list sent corresponds to the offset. Missing values are not permitted. For example, if you want to change the value of offset “B”, you must send all values up to 2.

- The default values are set according to [:SENSE]:RADio:CARRier[:TYPE]:ACTual? setting as defined in Defaults table shown above.
- If you have set Carrier Config ([:SENSE]:RADio:CARRier[:TYPE]) to AUTO, the value is set to the default value described in “Factory Preset:” above according to the actual carrier configuration detected (you can see detected carrier configuration by sending [:SENSE]:RADio:CARRier[:TYPE]:ACTual?) You can not change this value. Even if the you set this value using SCPI, it is ignored and the default value is used.
- You must always send two <freq> values regardless of the [:SENSE]:RADio:CARRier[:TYPE] setting. The first value is for offset “A” and the second is for offset “B”. Note that the offset “B” value is only used when [:SENSE]:RADio:CARRier[:TYPE]? returns O50, but two values are always needed when the you send this command. If you send only one value, “-109 Missing parameter” is returned.
- When sending this query form of this command, the second element of the responded array is always present but only used when [:SENSE]:RADio:CARRier[:TYPE]:ACTual? returns O50.

### Adjacent Channel Power—Define Offset Frequency List

*iDEN mode (E4406A)*

```
[:SENSE]:ACP:OFFSet[:FREQuency] <f_offset>
```

```
[:SENSE]:ACP:OFFSet[:FREQuency] ?
```

*Basic mode (E4406A),*

```
[:SENSE]:ACP:OFFSet:LIST[:FREQuency]  
<f_offset>,<f_offset>,<f_offset>,<f_offset>,<f_offset>
```

```
[:SENSE]:ACP:OFFSet:LIST[:FREQuency] ?
```

*WiDEN mode (E4406A)*

```
[:SENSE]:ACP:OFFSet:LIST[:FREQuency]  
<f_offset>,<f_offset>
```

```
[:SENSE]:ACP:OFFSet:LIST[:FREQuency] ?
```

*cdma2000, W-CDMA mode*

```
[ :SENSE ] :ACP:OFFSet [n] :LIST [ :FREQuency ]
<f_offset>, <f_offset>, <f_offset>, <f_offset>, <f_offset>
```

```
[ :SENSE ] :ACP:OFFSet [n] :LIST [ :FREQuency ] ?
```

*cdmaOne mode*

```
[ :SENSE ] :ACP:OFFSet [n] :LIST [n] [ :FREQuency ]
<f_offset>, <f_offset>, <f_offset>, <f_offset>, <f_offset>
```

```
[ :SENSE ] :ACP:OFFSet [n] :LIST [n] [ :FREQuency ] ?
```

Enables you to define the custom set of offset frequencies at which the switching transient spectrum part of the ACP measurement will be made. The list contains up to five (5) entries, depending on the mode selected, for offset frequencies. Each offset frequency in the list corresponds to a reference bandwidth in the bandwidth list.

An offset frequency of zero turns the display of the measurement for that offset off, but the measurement is still made and reported. You can turn off (not use) specific offsets with the [:SENSE]:ACP:OFFSet:LIST:STATe command (*not available in WiDEN mode (E4406A)*).

Offset[n]            n=1 is base station and 2 is mobiles. The default is base station (1).

List[n]             n=1 is cellular bands and 2 is pcs bands. The default is cellular.

Example:            *WiDEN mode (E4406A)*:

(Example #1)    When [:SENSE]:RADio:CARRier [:TYPE]:ACTual? returns I25, I50, I75, or I100, and you want to set the offset frequency of offset A to 100 kHz, send: ACP:OFFS:LIST 100e3, 10e3 (the second value can be arbitrary but it is needed).

(Example #2)    When [:SENSE]:RADio:CARRier [:TYPE]:ACTual? returns O50, and you want to set the offset frequencies of offset A and B to 75 kHz and 10 kHz respectively, send: ACP:OFFS:LIST 75e3, 10e3

State Saved:      Saved in Instrument State

Factory Preset: *WiDEN mode (E4406A)*

Carrier Configuration Setting	Default	
	A	B
Auto	Actual value depends on detected carrier configuration and cannot be changed.	
25 kHz	25.0 kHz	N/A
50 kHz	37.5 kHz	N/A
50 kHz outer	62.5 kHz	12.5 kHz
75 kHz	50.0 kHz	N/A
100 kHz	62.5 kHz	N/A

Factory Preset: *iDEN mode (E4406A), Basic mode (E4406A), cdma2000, W-CDMA mode*

Mode	Variant	Offset A	Offset B	Offset C	Offset D	Offset E
<b>iDEN (E4406A)</b>		25 kHz	n/a	n/a	n/a	n/a
<b>WiDEN (E4406A)</b>		62.5 kHz	n/a	n/a	n/a	n/a
<b>Basic (E4406A)</b>		750 kHz	1.98 MHz	0 Hz	0 Hz	0 Hz
<b>cdmaOne</b>	BS cellular	750 kHz	1.98 MHz	0 Hz	0 Hz	0 Hz
	BS pcs	885 kHz	1.25625 MHz	2.75 MHz	0 Hz	0 Hz
	MS cellular	885 kHz	1.98 MHz	0 Hz	0 Hz	0 Hz
	MS pcs	1.265 MHz	0 Hz	0 Hz	0 Hz	0 Hz
<b>cdma2000</b>	BTS	750 kHz	1.98 MHz	0 Hz	0 Hz	0 Hz
	MS	885 kHz	1.98 MHz	0 Hz	0 Hz	0 Hz
<b>W-CDMA</b>		5 MHz	10 MHz	15 MHz	20 MHz	25 MHz

Range: 0 Hz to 45 MHz for cdmaOne  
0 Hz to 20 MHz for iDEN, Basic, WiDEN (E4406A)  
0 Hz to 100 MHz for cdma2000, W-CDMA

Default Unit: Hz

Remarks: For E4406A you must be in Basic, cdmaOne, cdma2000, W-CDMA, WiDEN, or iDEN mode to use this command. Use INSTRument:SElect to set the mode.

For E4406A WiDEN mode:

- When you set these values remotely, the position of each value in the list sent corresponds to the offset. Missing values are not permitted. For example, if you want to change the value of offset “B”, you must send all values up to 2.
- The default values are set according to [:SENSE]:RADio:CARRier[:TYPE]:ACTual? setting as defined in Defaults table shown above.
- If you have set Carrier Config ([:SENSE]:RADio:CARRier[:TYPE]) to AUTO, the value is set to the default value described in “Factory Preset:” above according to the actual carrier configuration detected (you can see detected carrier configuration by sending [:SENSE]:RADio:CARRier[:TYPE]:ACTual?) You can not change this value. Even if the you set this value using SCPI, it is ignored and the default value is used.
- You must always send two <freq> values regardless of the [:SENSE]:RADio:CARRier[:TYPE] setting. The first value is for offset “A” and the second is for offset “B”. Note that the offset “B” value is only used when [:SENSE]:RADio:CARRier[:TYPE]? returns O50, but two values are always needed when the you send this command. If you send only one value, “-109 Missing parameter” is returned.
- When sending this query form of this command, the second element of the responded array is always present but only used when [:SENSE]:RADio:CARRier[:TYPE]:ACTual? returns O50.

Front Panel

Access: **Meas Setup, Ofs & Limits**

### Adjacent Channel Power—Amplitude Limits Relative to the Carrier

*iDEN mode* (E4406A)

```
[:SENSE]:ACP:OFFSet:RCARRier <rel_power>
```

```
[:SENSE]:ACP:OFFSet:RCARRier?
```

*WiDEN mode* (E4406A)

```
[ :SENSe ] :ACP:OFFSet:LIST:RCARrier <rel_power>,<rel_power>
```

```
[ :SENSe ] :ACP:OFFSet:LIST:RCARrier?
```

*Basic mode (E4406A)*

```
[ :SENSe ] :ACP:OFFSet:LIST:RCARrier  
<rel_power>,<rel_power>,<rel_power>,<rel_power>,<rel_power>
```

```
[ :SENSe ] :ACP:OFFSet:LIST:RCARrier?
```

*cdma2000, W-CDMA mode*

```
[ :SENSe ] :ACP:OFFSet [n] :LIST:RCARrier  
<rel_power>,<rel_power>,<rel_power>,<rel_power>,<rel_power>
```

```
[ :SENSe ] :ACP:OFFSet [n] :LIST:RCARrier?
```

*cdmaOne mode*

```
[ :SENSe ] :ACP:OFFSet [n] :LIST [n] :RCARrier  
<rel_power>,<rel_power>,<rel_power>,<rel_power>,<rel_power>
```

```
[ :SENSe ] :ACP:OFFSet [n] :LIST [n] :RCARrier?
```

Sets the amplitude levels to test against for any custom offsets. This amplitude level is relative to the carrier amplitude. If multiple offsets are available, the list contains five (5) entries. The offset closest to the carrier channel is the first one in the list.

[ :SENSe ] :ACP:OFFSet [n] :LIST [n] :TEST selects the type of testing to be done at each offset.

You can turn off (not use) specific offsets with the [ :SENSe ] :ACP:OFFSet [n] :LIST [n] :STATe command.

The query returns the five (5) sets of the real numbers that are the current amplitude test limits, relative to the carrier, for each offset.

Offset [n]            n=1 is base station and 2 is mobiles. The default is base station (1).

List [n]             n=1 is cellular bands and 2 is pcs bands. The default is cellular.

Factory Preset: *WiDEN mode (E4406A)*

Carrier Configuration Setting	Default	
	A	B
Auto	Actual value depends on detected carrier configuration and cannot be changed.	
25 kHz	-50.0 dBc	N/A
50 kHz	-50.0 dBc	N/A

Carrier Configuration Setting	Default	
	A	B
50 kHz outer	-50.0 dBc	-50.0 dBc
75 kHz	-50.0 dBc	N/A
100 kHz	-50.0 dBc	N/A

Factory Preset:

Mode	Variant	Offset A	Offset B	Offset C	Offset D	Offset E
<b>iDEN</b> (E4406A)		0 dBc	n/a	n/a	n/a	n/a
<b>Basic</b> (E4406A)		-45 dBc	-60 dBc	0 dBc	0 dBc	0 dBc
<b>cdmaOne</b>	BS cellular	-45 dBc	-60 dBc	0 dBc	0 dBc	0 dBc
	BS pcs	-45 dBc	0 dBc	0 dBc	0 dBc	0 dBc
	MS cellular	-42 dBc	-54 dBc	0 dBc	0 dBc	0 dBc
	MS pcs	-42 dBc	0 dBc	0 dBc	0 dBc	0 dBc
<b>cdma2000</b>		0 dBc	0 dBc	0 dBc	0 dBc	0 dBc
<b>W-CDMA</b>	BTS	-44.2 dBc	-49.2 dBc	-49.2 dBc	-49.2 dBc	-49.2 dBc
	MS	-32.2 dBc	-42.2 dBc	-42.2 dBc	-42.2 dBc	-42.2 dBc

Range: -150.0 dB to 50.0 dB for cdmaOne, cdma2000, W-CDMA, Basic (E4406A), WiDEN (E4406A)  
-200.0 dB to 50.0 dB for iDEN (E4406A)

Default Unit: dB

Remarks: For E4406A you must be in Basic, cdmaOne, cdma2000, W-CDMA, WiDEN, or iDEN mode to use this command. Use INSTRUMENT:SELEct to set the mode.

For E4406A WiDEN mode:

- When you set these values remotely, the position of each value in the list sent corresponds to the offset. Missing values are not permitted. For example, if you want to change the value of offset “B”, you must send all values up to 2.
- The default values are set according to [:SENSE]:RADIO:CARRIER[:TYPE]:ACTUAL? setting as defined in Defaults table shown above.
- If you have set Carrier Config

([:SENSe]:RADio:CARRier[:TYPE]) to AUTO, the value is set to the default value described in “[Factory Preset:](#)” above according to the actual carrier configuration detected (you can see detected carrier configuration by sending [:SENSe]:RADio:CARRier[:TYPE]:ACTual?) You can not change this value. Even if the you set this value using SCPI, it is ignored and the default value is used.

- You must always send two <freq> values regardless of the [:SENSe]:RADio:CARRier[:TYPE] setting. The first value is for offset “A” and the second is for offset “B”. Note that the offset “B” value is only used when [:SENSe]:RADio:CARRier[:TYPE]? returns O50, but two values are always needed when the you send this command. If you send only one value, “-109 Missing parameter” is returned.
- When sending this query form of this command, the second element of the responded array is always present but only used when [:SENSe]:RADio:CARRier[:TYPE]:ACTual? returns O50.

Front Panel

Access: **Meas Setup, Ofs & Limits, Rel Lim (Car)** (iDEN or WiDEN mode)

### Adjacent Channel Power—Amplitude Limits Relative to the Power Spectral Density

*iDEN mode*

```
[:SENSe]:ACP:OFFSet:RPSDensity <rel_power>
```

```
[:SENSe]:ACP:OFFSet:RPSDensity?
```

*Basic mode*

```
[:SENSe]:ACP:OFFSet:LIST:RPSDensity  
<rel_powr>, <rel_powr>, <rel_powr>, <rel_powr>, <rel_powr>
```

```
[:SENSe]:ACP:OFFSet:LIST:RPSDensity?
```

*cdmaOne, cdma2000, W-CDMA mode*

```
[:SENSe]:ACP:OFFSet [n] :LIST [n] :RPSDensity  
<rel_powr>, <rel_powr>, <rel_powr>, <rel_powr>, <rel_powr>
```

```
[:SENSe]:ACP:OFFSet [n] :LIST [n] :RPSDensity?
```

Sets the amplitude levels to test against for any custom offsets. This



amplitude level is relative to the power spectral density. If multiple offsets are available, the list contains five (5) entries. The offset closest to the carrier channel is the first one in the list.

ACP:OFFS[n]:LIST[n]:TEST selects the type of testing to be done at each offset.

You can turn off (not use) specific offsets with the SENS:ACP:OFFSet:LIST:STATe command.

The query returns five (5) real numbers that are the current amplitude test limits, relative to the power spectral density, for each offset.

Offset[n]            n=1 is base station and 2 is mobiles. The default is base station (1).

List[n]

*cdmaOne mode*    n=1 is cellular bands and 2 is pcs bands. The default is cellular.

*cdma2000 mode*   n=1 is SR1, 2 is SR3 DS, and 3 is SR3 MC. The default is SR1 (1).

*W-CDMA mode*    n=1 is ARIB, 2 is 3GPP, and 3 is Trial. The default is ARIB (1).

Factory Preset and \*RST:

Mode	Variant	Offset A	Offset B	Offset C	Offset D	Offset E
iDEN		0 dB	n/a	n/a	n/a	n/a
Basic		-28.87 dB	-43.87 dB	0 dB	0 dB	0 dB
cdmaOne	BS cellular	-28.87 dB	-43.87 dB	0 dB	0 dB	0 dB
	BS pcs	-28.87 dB	0 dB	0 dB	0 dB	0 dB
	MS cellular	-25.87 dB	-37.87 dB	0 dB	0 dB	0 dB
	MS pcs	-25.87 dB	0 dB	0 dB	0 dB	0 dB
cdma2000		0 dB	0 dB	0 dB	0 dB	0 dB
W-CDMA		0 dB	0 dB	0 dB	0 dB	0 dB

Range:                -150 dB to 50 dB for cdmaOne, Basic, cdma2000, W-CDMA mode

                          -200 dB to 50 dB for iDEN mode

Default Unit:    dB

Remarks:        You must be in Basic, cdmaOne, cdma2000, W-CDMA, iDEN mode to use this command. Use INSTRument:SElect to set the mode.

## Adjacent Channel Power—Define Type of Offset Frequency List

*iDEN or WiDEN mode (E4406A)*

```
[[:SENSe]:ACP:OFFSet:TEST ABSolute|AND|OR|RELative
```

```
[[:SENSe]:ACP:OFFSet:TEST?
```

*Basic mode (E4406A)*

```
[[:SENSe]:ACP:OFFSet:LIST:TEST ABSolute|AND|OR|RELative,  
ABSolute|AND|OR|RELative, ABSolute|AND|OR|RELative,  
ABSolute|AND|OR|RELative, ABSolute|AND|OR|RELative
```

```
[[:SENSe]:ACP:OFFSet:LIST:TEST?
```

*cdma2000, W-CDMA mode*

```
[[:SENSe]:ACP:OFFSet [n]:LIST:TEST ABSolute|AND|OR|RELative,  
ABSolute|AND|OR|RELative, ABSolute|AND|OR|RELative,  
ABSolute|AND|OR|RELative, ABSolute|AND|OR|RELative
```

```
[[:SENSe]:ACP:OFFSet [n]:LIST:TEST?
```

*cdmaOne mode*

```
[[:SENSe]:ACP:OFFSet [n]:LIST [n]:TEST,  
ABSolute|AND|OR|RELative,  
ABSolute|AND|OR|RELative, ABSolute|AND|OR|RELative,  
ABSolute|AND|OR|RELative
```

```
[[:SENSe]:ACP:OFFSet [n]:LIST [n]:TEST?
```

Defines the type of testing to be done at any custom offset frequencies. The measured powers are tested against the absolute values defined with [:SENSe]:ACP:OFFSet[n]:LIST:ABSolute, or the relative values defined with [:SENSe]:ACP:OFFSet:LIST:RPSDensity and [:SENSe]:ACP:OFFSet:LIST:RCARrier.

You can turn off (not use) specific offsets with the [:SENS]:ACP:OFFSet:LIST:STATE command. (Not available in WiDEN mode.)

Offset[n]            n=1 is base station and 2 is mobiles. The default is base station (1).

List[n]             *cdmaOne mode* n=1 is cellular bands and 2 is pcs bands. The default is cellular.

*cdma2000 mode* n=1 is SR1, 2 is SR3 DS, and 3 is SR3 MC. The default is SR1 (1).

*W-CDMA mode* n=1 is ARIB, 2 is 3GPP, and 3 is Trial. The default is ARIB (1).

The types of testing that can be done for each offset include:

- Absolute - Test the absolute power measurement. If it fails, then return a failure for the measurement at this offset.
- And - Test both the absolute power measurement and the power relative to the carrier. If they both fail, then return a failure for the measurement at this offset.
- Or - Test both the absolute power measurement and the power relative to the carrier. If either one fails, then return a failure for the measurement at this offset.
- Relative - Test the power relative to the carrier. If it fails, then return a failure for the measurement at this offset.
- OFF - Turns the power test off.

Factory Preset:

Mode	Variant	Offset A	Offset B	Offset C	Offset D	Offset E
iDEN (E4406A)		REL	n/a	n/a	n/a	n/a
WiDEN (E4406A)		REL <sup>a</sup>	REL <sup>a</sup>	n/a	n/a	n/a
Basic (E4406A)		REL	REL	REL	REL	REL
cdmaOne	BS cellular	REL	REL	REL	REL	REL
	BS pcs	REL	ABS	ABS	REL	REL
	MS cellular	REL	REL	REL	REL	REL
	MS pcs	REL	ABS	ABS	REL	REL
cdma2000		REL	REL	REL	REL	REL
W-CDMA		REL	REL	REL	REL	REL

a. Parameters for Offset A and Offset B are set by a common command, therefore they are always the same.

Remarks: For E4406A you must be in Basic, cdmaOne, cdma2000, W-CDMA, WiDEN, or iDEN mode to use this command. Use INSTRument:SElect to set the mode.

Front Panel

Access: **Meas Setup, Ofs & Limits, Fail (iDEN)**

**Meas Setup, Ofs & Limits, Composite Fail (WiDEN)**

### Adjacent Channel Power—Spectrum Trace Control

**[ :SENSe ] :ACP:SPECTrum:ENABLE OFF | ON | 0 | 1**

**[ :SENSe ] :ACP:SPECTrum:ENABLE?**

Turns on/off the measurement of the spectrum trace data when the spectrum view is selected. (Select the view with DISPLAY:ACP:VIEW.) You may want to disable the spectrum trace data part of the measurement so you can increase the speed of the rest of the measurement data.

Factory Preset  
and \*RST: On

Remarks: You must be in Basic, cdmaOne, cdma2000, W-CDMA, iDEN mode to use this command. Use INSTRUMENT:SElect to set the mode.

History: Revision A.03.27 or later

## Adjacent Channel Power—Trigger Source

**[ :SENSe ] :ACP:TRIGger:SOURce**  
**EXtErnal [1] | EXtErnal2 | FRAMe | IF | IMMEdiate | RFBurst**

**[ :SENSe ] :ACP:TRIGger:SOURce?**

Select the trigger source used to control the data acquisitions.

External 1 – front panel external trigger input

External 2 – rear panel external trigger input

Frame – internal frame trigger from front panel input

IF – internal IF envelope (video) trigger

Immediate – the next data acquisition is immediately taken, capturing the signal asynchronously (also called free run).

RF Burst – internal wideband RF burst envelope trigger that has automatic level control for periodic burst signals.

Factory Preset

and \*RST: IMMEdiate for BS

RFBurst for MS

RFBurst for iDEN and WiDEN

Range: EXT1 | EXT2 | IMM | RFB for Basic mode

Remarks: You must be in Basic, iDEN, WiDEN, NADC or PDC mode to use this command. Use INSTRUMENT:SELEct to set the mode.

In Basic mode, for offset frequencies >12.5 MHz, the external triggers will be a more reliable trigger source than RF burst. Also, you can use the Waveform measurement to set up trigger delay.

## Correction for Base Station RF Port External Attenuation

**[ :SENSe ] :CORRection:BS[:RF]:LOSS <rel\_power>**

**[ :SENSe ] :CORRection:BS[:RF]:LOSS?**

Set the correction equal to the external attenuation used when measuring base stations.

Factory Preset

and \*RST: 0 dB

Range: 0 to 100 dB for cdmaOne

–50 to 50 dB for Basic, iDEN, NADC or PDC

Default Unit: dB

Remarks: You must be in the Basic, iDEN, cdmaOne, NADC or PDC mode to use this command. Use INSTRUMENT:SElect to set the mode.

Value is global to the current mode.

## Correction for Mobile Station RF Port External Attenuation

`[ :SENSe ] :CORRection:MS [ :RF ] :LOSS <rel_power>`

`[ :SENSe ] :CORRection:MS [ :RF ] :LOSS?`

Set the correction equal to the external attenuation used when measuring mobile stations.

Factory Preset

and \*RST: 0 dB

Range: –50 to 50 dB

Default Unit: dB

Remarks: You must be in the iDEN mode to use this command. Use INSTRUMENT:SElect to set the mode.

Value is global to the current mode.

## Occupied Bandwidth Measurement

Commands for querying the occupied bandwidth measurement results and for setting to the default values are found in the “MEASure Group of Commands” on page 138. The equivalent front panel keys for the parameters described in the following commands, are found under the **Meas Setup** key, after the **Occupied BW** measurement has been selected from the **MEASURE** key menu.

### Occupied Bandwidth—Average Count

**[[:SENSe]:OBW:AVERAge:COUNT <integer>**

**[[:SENSe]:OBW:AVERAge:COUNT?**

Set the number of data acquisitions that will be averaged. After the specified number of average counts, the average mode (termination control) setting determines the average action.

Factory Preset: 10

Range: 1 to 10,000

Remarks: This command is used for measurements in the MEASURE menu.

You must be in the iDEN, WiDEN mode to use this command. Use INSTRument:SElect to set the mode.

History: Version A.02.00 or later

Front Panel

Access: **Meas Setup, Avg Number**

### Occupied Bandwidth—Averaging State

**[[:SENSe]:OBW:AVERAge[:STATe] OFF | ON | 0 | 1**

**[[:SENSe]:OBW:AVERAge[:STATe]?**

Turn the averaging function on or off.

Factory Preset: ON

Remarks: You must be in the PDC, cdma2000, W-CDMA, or 1xEV-DO mode to use this command. Use INSTRument:SElect to set the mode.

History: Version A.02.00 or later

Front Panel

Access: **Meas Setup, Avg Number**

### Occupied Bandwidth—Averaging Termination Control

**[[:SENSe]:OBW:AVERAge:TCONtrol EXPonential | REPeat**

**[[:SENSe]:OBW:AVERAge:TCONtrol?**

Select the type of termination control used for the averaging function. This determines the averaging action after the specified number of data acquisitions (average count) is reached.

**EXPonential** - After the average count is reached, each successive data acquisition is exponentially weighted and combined with the existing average.

**REPeat** - After reaching the average count, the averaging is reset and a new average is started.

Factory Preset: **EXPonential** for PDC, iDEN, WiDEN

**REPeat** for cdma2000, W-CDMA, 1xEV-DO

Remarks: You must be in the PDC, cdma2000, W-CDMA, iDEN, WiDEN, or 1xEV-DO mode to use this command. Use **INSTRument:SElect** to set the mode.

History: Version A.02.00 or later

Front Panel

Access: **Meas Setup, Avg Mode**

### Occupied Bandwidth—Percent of Total Power

**[[:SENSe]:OBWidth:PERCent <number>**

**[[:SENSe]:OBWidth:PERCent?**

Set the percentage of the total power for which the occupied bandwidth is calculated.

Factory Preset

and **\*RST**: 99%

Range: 0.1% to 99.9%

Default Unit: percent

Remarks: You must be in the iDEN, WiDEN mode to use this command. Use **INSTRument:SElect** to set the mode.

Front Panel

Access: **Meas Setup, Occ BW % Pwr**

**Meas Setup, % Pwr (iDEN, WiDEN)**



## Occupied Bandwidth—Trigger Source

**[ :SENSE ] :OBW:TRIGger:SOURCE**  
**EXTERNAL [1] | EXTERNAL2 | IF | IMMEDIATE | RFBURST**

**[ :SENSE ] :OBwidth:TRIGger:SOURCE?**

Select the trigger source used to control the data acquisitions for the occupied bandwidth measurement.

External 1 – rear panel external trigger input

External 2 – front panel external trigger input

IF – internal IF envelope (video) trigger

Immediate – the next data acquisition is immediately taken, capturing the signal asynchronously (also called free run)

RF Burst – internal wideband RF burst envelope trigger that has automatic level control for periodic burst signals

Factory Preset

and \*RST: Immediate

Immediate for BS

RF Burst for MS

IF for iDEN, WiDEN

Remarks: You must be in the PDC, iDEN, WiDEN mode to use this command. Use INSTRUMENT:SELECT to set the mode.

History: Version A.02.00 or later

Front Panel

Access: Meas Setup, Trig Source

## RF Port Power Range Auto

**[ :SENSE ] :POWER[:RF]:RANGE:AUTO OFF | ON | 0 | 1**

**[ :SENSE ] :POWER[:RF]:RANGE:AUTO?**

Select the RF port power range to be set either automatically or manually.

ON - power range is automatically set as determined by the actual measured power level at the start of a measurement.

OFF - power range is manually set

Factory Preset: ON

Remarks: You must be in the cdmaOne, GSM, EDGE, NADC,

PDC, cdma2000, W-CDMA, iDEN, or WiDEN mode to use this command. Use INSTRUMENT:SElect to set the mode.

Front Panel

Access: **Input, Max Total Pwr (at UUT)**

## Power vs. Time Measurement

Commands for querying the power versus time measurement results and for setting to the default values are found in the “MEASure Group of Commands” on page 138. The equivalent front panel keys for the parameters described in the following commands, are found under the **Meas Setup** key, after the **Power vs Time** measurement has been selected from the **MEASURE** key menu.

### Power vs. Time—Number of Bursts Averaged

**[ :SENSe ] :PVTime:AVERAge:COUNT <integer>**

**[ :SENSe ] :PVTime:AVERAge:COUNT?**

Set the number of bursts that will be averaged. After the specified number of bursts (average counts), the averaging mode (termination control) setting determines the averaging action.

Factory Preset: 15

16 for iDEN, WiDEN

100 for 1xEV-DO

Range: 1 to 10,000

Remarks: For E4406A you must be in the EDGE(w/GSM), GSM, 1xEV-DO, W-CDMA, iDEN, WiDEN, or Service mode to use this command. Use INSTRUMENT:SElect to set the mode.

### Power vs. Time—Averaging Type

*EDGE (w/GSM), GSM, Service mode*

**[ :SENSe ] :PVTime:AVERAge:TYPE**  
**LOG | MAXimum | MINimum | MXMinimum | RMS**

*iDEN, WiDEN mode*

**[ :SENSe ] :PVTime:AVERAge:TYPE**  
**LOG | MAXimum | MINimum | MXMinimum | RMS | POWER**

*1xEV-DO mode*

**[ :SENSe ] :PVTTime:AVERAge:TYPE LOG | MAXimum | MINimum | RMS | SCALar**

*W-CDMA mode*

**[ :SENSe ] :PVTTime:AVERAge:TYPE RMS | MAXimum | MINimum**

**[ :SENSe ] :PVTTime:AVERAge:TYPE?**

Select the type of averaging to be performed.

LOG - The log of the power is averaged. (This is also known as video averaging.)

MAXimum - The maximum values are retained.

MINimum - The minimum values are retained.

MXMinimum - Both the maximum and the minimum values are retained. (E4406A - EDGE(W/GSM), GSM, and Service modes, and PSA - only)

RMS - The power is averaged to provide a voltage rms value.

SCALar - The amplitude level of power is averaged to provide a voltage value. (1xEV-DO mode only)

POWER - averages the linear power of successive measurements.

Factory Preset: RMS

Remarks: For E4406A you must be in the EDGE(w/GSM), GSM, 1xEV-DO, W-CDMA, iDEN, WiDEN or Service mode to use this command. Use INSTRument:SELEct to set the mode.

### Power vs. Time—Resolution BW

**[ :SENSe ] :PVTTime:BANDwidth | BWIDth [ :RESolution ] <freq>**

**[ :SENSe ] :PVTTime:BANDwidth | BWIDth [ :RESolution ] ?**

Enables you to set the resolution bandwidth. This is an advanced control that normally does not need to be changed. Setting this to a value other than the factory default, may cause invalid measurement results.

Factory Preset: 1.5 MHz

5.0 MHz for W-CDMA

30 kHz for iDEN

120 kHz for WiDEN

Range: 1 kHz to 5 MHz

1.0 kHz to 10.0 MHz when PVT:BAND:RES:TYPE is set to FLATtop

1.0 kHz to 8.0 MHz when PVT:BAND:RES:TYPE is set to GAUSSian

Default Unit: Hz

Remarks: For E4406A you must be in the EDGE(w/GSM), GSM, Service, 1xEV-DO, iDEN, WiDEN, or W-CDMA mode to use this command. Use INSTRUMENT:SElect to set the mode.

Front Panel

Access: Meas Setup, Advanced, Res BW

### Power vs. Time—RBW Filter Type

**[ :SENSe ] :PVTime :BANDwidth | BWIDth [ :RESolution ] :TYPE  
FLATtop | GAUSSian**

**[ :SENSe ] :PVTime :BANDwidth | BWIDth [ :RESolution ] :TYPE?**

Enables you to select the type of resolution bandwidth filter. This is an advanced control that normally does not need to be changed. Setting this to a value other than the factory default, may cause invalid measurement results.

FLATtop - a filter with a flat amplitude response, which provides the best amplitude accuracy.

GAUSSian - a filter with Gaussian characteristics, which provides the best pulse response.

Factory Preset: GAUSSian

FLATtop for 1xEV-DO, W-CDMA, WiDEN

Remarks: For E4406A you must be in the EDGE(w/GSM), GSM, Service, 1xEV-DO, iDEN, WiDEN, or W-CDMA mode to use this command. Use INSTRUMENT:SElect to set the mode.

Front Panel Access: Meas Setup, Advanced (iDEN, WiDEN mode).

### Power vs. Time—Carrier Estimate Interval

**[ :SENSe ] :PVTime :CEStimate : [TIME] <time**

**[ :SENSe ] :PVTime :CEStimate : [TIME] ?**

Enables you to set the time interval between carrier estimation. The measurement keeps a timer, only when the timer expires will the

measurement perform carrier estimation, then reset the timer.

Factory Preset: 10.000 s

Range: 0 s to 200 s

Remarks: You must be in the iDEN or WiDEN mode to use this command. Use INSTRument:SElect to set the mode.

Front Panel

Access: Meas Setup, Carr Est Time

### Power vs. Time—Lower Mask Absolute Amplitude Levels (Remote Command Only)

```
[ :SENSe ] :PVTime:MASK:LIST:LOWer:ABSolute <power>, <power>, <power>, <power>, <power>
```

```
[ :SENSe ] :PVTime:MASK:LIST:LOWer:ABSolute?
```

Enter a power level for any of your mask line segments that require an absolute minimum power limit in addition to its relative limit. Each time a measurement is made the Ref Level is determined. (This is the power level of the useful part of the burst, or midway between the upper/lower masks). Remember, as the power of the Ref Level changes, all of the relative mask power levels will change by the same amount.

Each relative limit is then compared to the Ref Level and an equivalent absolute power level is calculated. This power level is compared to the specified absolute limit for each line segment. If this calculated relative limit is lower than the absolute limit you've specified, then the value of the absolute limit is used for this segment. Therefore, if the absolute limit is set to a very low value (–200 dBm), the calculated value of the reference limit will never be lower, and the specified relative limit will always be used for that segment. See [Figure 5-2 on page 201](#).

Every time point you defined with PVTime:MASK:LOW:TIME must have a power value defined in the same order. You can put a comma in the SCPI command as a place holder for any points where an absolute power is not specified, and that segment will then use the default value.

Factory Preset

and \*RST: Selected standard

Range: –200 dBm to +100 dBm

Default Unit: dBm

Remarks: You must be in iDEN, WiDEN mode to use this command. Use INSTRument:SElect to set the mode.

### Power vs. Time—Lower Mask Points (Remote Command Only)

**[ :SENSe ] :PVTime:MASK:LIST:LOWer:POINTs?**

Query the number of elements in the lower mask. This value is determined by the number of time points entered using

[ :SENSe ] :PVTime:MASK:LIST:LOWer:TIME.

Factory Preset

and \*RST: 2

Range: integer, 1 to 25

Remarks: You must be in EDGE(w/GSM), iDEN, or WiDEN mode to use this command. Use INSTRUMENT:SElect to set the mode.

### Power vs. Time—Lower Mask Relative Amplitude Levels (Remote Command Only)

**[ :SENSe ] :PVTime:MASK:LIST:LOWer:RELative <rel\_power>, <rel\_power>, <rel\_power>, <rel\_power>**

**[ :SENSe ] :PVTime:MASK:LIST:LOWer:RELative?**

Enter the relative power level for each horizontal line segment in the lower limit mask. There should be a power level for each time point entered using [ :SENSe ] :PVTime:MASK:LIST:LOWer:TIME, and they must be entered in the same order. These power levels are all relative to the defined Reference Power Level (the average power in the useful part of the data).

Any portion of the signal that has no limit line segment defined for it, will default to a very low limit (–100 dB relative to the reference power). This will keep the measurement from indicating a failure for that portion of the data.

Factory Preset

and \*RST: Selected standard

Range: +200 dB to –100 dB, relative to the reference power

Default Unit: dB

Remarks: You must be in EDGE(w/GSM), iDEN, or WiDEN mode to use this command. Use INSTRUMENT:SElect to set the mode.

### Power vs. Time—Lower Mask Time Points (Remote Command Only)

**[ :SENSe ] :PVTime:MASK:LIST:LOWer:TIME <seconds>, <seconds>, <seconds>, <seconds>, <seconds>**

**[ :SENSe] :PVTime:MASK:LIST:LOWer:TIME?**

Enter the time points that define the horizontal line segments of the lower limit. A reference point designated “ $t_0$ ” is at the center of the useful data (usually the center of the burst). Each line segment to the right of the  $t_0$  reference point is designated as a positive time value and each segment to the left of  $t_0$  is a negative time value.

First enter positive values in sequence starting from  $t_0$ , then negative values in sequence starting from  $t_0$ . See [Figure 5-2 on page 201](#) and the [ :SENSe] :PVTime:MASK:LIST:UPPER:TIME example below it. (This is an upper mask example, but they work the same.)

We recommend that you select a large time value for your first and last mask points (e.g. -1 and +1 second). This guarantees that you’ve defined a limit for all the measured data. (See Mask Segments 4 and 9 in the [Table 5-2 on page 201](#) for an example.)

Factory Preset

and \*RST: Selected standard

Range: -1 s to +1 s, referenced to  $t_0$  at the center of the useful data (burst center)

1 to 25 time points in a mask

Default Unit: seconds

Remarks: You must be in the EDGE(w/GSM), iDEN, WiDEN mode to use this command. Use INSTRument:SElect to set the mode.

**Power vs. Time—Upper Mask Absolute Amplitude Levels (Remote Command Only)**

[ :SENSe] :PVTime:MASK:LIST:UPPER:ABSolute <power>, <power>, <power>, <power>, <power>

**[ :SENSe] :PVTime:MASK:LIST:UPPER:ABSolute?**

Enter a power level for any of your mask line segments that require an absolute minimum power limit in addition to its relative limit. Each time a measurement is made the Ref Level is determined. (This is the power level of the useful part of the burst, or midway between the upper/lower masks). Remember, as the power of the Ref Level changes, all of the relative mask power levels will change by the same amount.

Each relative limit is then compared to the Ref Level and an equivalent absolute power level is calculated. This power level is compared to the specified absolute limit for each line segment. If this calculated relative limit is lower than the absolute limit you’ve specified, then the value of the absolute limit is used for this segment. Therefore, if the absolute

limit is set to a very low value (–200 dBm), the calculated value of the reference limit will never be lower, and the specified relative limit will always be used for that segment. See [Figure 5-2 on page 201](#).

Every time point you defined with PVT:MASK:LOW:TIME must have a power value defined in the same order. You can put a comma in the SCPI command as a place holder for any points where an absolute power is not specified, and that segment will then use the default value.

Example: **PVT:MASK:LIST:UPP:ABS -200, -200, -58, -200, -200, -200, -200, -58, -200**

Factory Preset  
and \*RST: Selected standard

Range: –200 dBm to +100 dBm

Default Unit: dBm

Remarks: You must be in EDGE(w/GSM), iDEN, WiDEN mode to use this command. Use INSTRUMENT:SElect to set the mode.

#### Power vs. Time—Upper Mask Points (Remote Command Only)

**[ :SENSe ] :PVTime:MASK:LIST:UPPer:POINTs?**

Query the number of elements in the upper mask. This value is determined by the number of time points entered using

**[ :SENSe ] :PVTime:MASK:LIST:UPPer:TIME.**

Factory Preset  
and \*RST: 2

Range: integer, 1 to 25

Remarks: You must be in EDGE(w/GSM), iDEN, WiDEN mode to use this command. Use INSTRUMENT:SElect to set the mode.

#### Power vs. Time—Upper Mask Relative Amplitude Levels (Remote Command Only)

**[ :SENSe ] :PVTime:MASK:LIST:UPPer:RElative <rel\_power>, <rel\_power>, <rel\_power>, <rel\_power>**

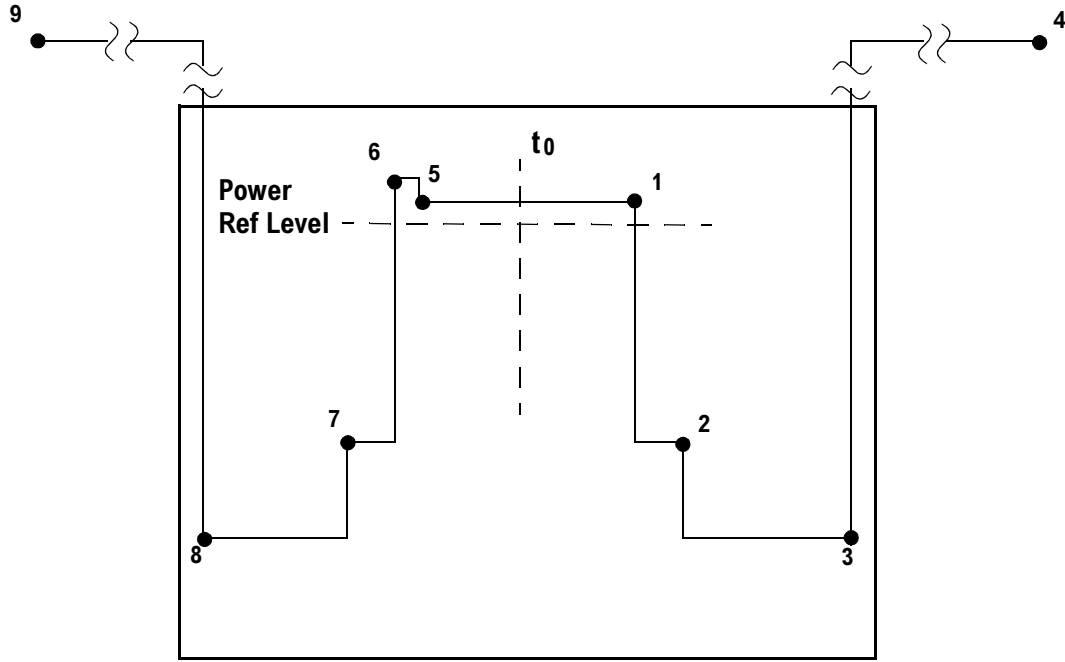
**[ :SENSe ] :PVTime:MASK:LIST:UPPer:RElative?**

Enter the relative power level for each horizontal line segment in the upper limit mask. There should be a power level for each time point entered using **[ :SENSe ] :PVTime:MASK:LIST:UPPer:TIME**, and they must be entered in the same order. These power levels are all relative to



the defined Reference Power Level (the average power in the useful part of the data). For an example of a mask, the associated date table, and SCPI example; see [Figure 5-2 on page 201](#).

**Figure 5-2 Custom Upper Limit Mask Example**



Entered Value for each Time Segment	Absolute Time Value	Relative Power (example (with Ref Level = -12 dBm))		Entered Absolute Power (dBm)	Segment Number
		Entered Relative Power	Equivalent Absolute Power		
280.0e-6	280 $\mu$ s	+4 dBc	-8 dBm	-200 dBm	1
15.0e-6	295 $\mu$ s	-32 dBc	-44 dBm	-200 dBm	2
450.0e-6	745 $\mu$ s	-48 dBc	-60 dBm <sup>a</sup>	-58 dBm <sup>a</sup>	3
1	>1 sec	+100 dBc	+112 dBm	-200 dBm	4
-270.0e-6	-270 $\mu$ s	+4 dBc	-8 dBm	-200 dBm	5
-10.0e-6	-280 $\mu$ s	+7 dBc	-5 dBm	-200 dBm	6
-20.0e-6	-300 $\mu$ s	-25 dBc	-37 dBm	-200 dBm	7
-450e-6	-750 $\mu$ s	-43 dBc	-55 dBm	-58 dBm	8
-1	<-1 sec	+100 dBc	+112 dBm	-200 dBm	9

- a. Notice that this segment, with this value of Ref Level, has a calculated relative level of -60 dBm. This is lower than the specified absolute level of -58 dBm, so the -58 dBm value will be used as the test limit for the segment.

Example: **PVT:MASK:LIST:UPP:REL 4, -32, -48, 100, 4, 7, -25, -43, 100**

Factory Preset and \*RST: Selected standard

Range: 200 dB to -100 dB, relative to the reference power

Default Unit: dB

Remarks: You must be in EDGE(w/GSM), iDEN, WiDEN mode to use this command. Use INSTRUMENT:SElect to set the mode.

#### Power vs. Time—Upper Mask Time Points (Remote Command Only)

**[[:SENSe]:PVTtime:MASK:LIST:UPPer:TIME <seconds>, <seconds>, <seconds>, <seconds>, <seconds>**

**[[:SENSe]:PVTtime:MASK:LIST:UPPer:TIME?**

Enter the time points that define the horizontal line segments of the upper limit. A reference point designated “ $t_0$ ” is at the center of the useful data (usually the center of the burst). Each line segment to the right of the  $t_0$  reference point is designated as a positive value and each segment to the left of  $t_0$  is a negative value.

First enter positive values in sequence starting from  $t_0$ , then the negative values in sequence starting from  $t_0$ . See [Figure 5-2 on page 201](#) and the `PVT:MASK:LIST:UPPER:TIME` example below it.

We recommend that you select a large time value for your first and last mask points (e.g. -1 and +1 second). This guarantees that you’ve defined a limit for all the measured data. (See Mask Segments 4 and 9 in the [Table 5-2 on page 201](#) for an example.

Example: **PVT:MASK:LIST:UPP:TIME 280e-6, 15e-6, 1, -270e-6, -10e-6, -20e-6, -1**

Factory Preset and \*RST: Selected standard

Range: -1 s to +1 s, referenced to  $t_0$  at the center of the useful data (burst center)

1 to 25 time points in a mask

Default Unit: seconds

Remarks: You must be in the EDGE(w/GSM), iDEN, WiDEN mode to use this command. Use INSTRUMENT:SELEct to set the mode.

### Power vs. Time—Custom Limit Masks (Remote Command Only)

**[ :SENSe ] :PVTime:MASK:SELEct STANDARD|CUSTOM**

**[ :SENSe ] :PVTime:MASK:SELEct?**

Select standard masks or user-defined custom masks to compare you measured data against.

Factory Preset  
and \*RST: STANDARD

Remarks: You must be in EDGE(w/GSM), iDEN, WiDEN mode to use this command. Use INSTRUMENT:SELEct to set the mode.

### Power vs. Time—Trigger Source

**[ :SENSe ] :PVTime:TRIGger:SOURce EXTErnal [1] | EXTErnal2  
| FRAMe | LINE | IF | IMMEDIATE | RFBURst**

**[ :SENSe ] :PVTime:TRIGger:SOURce?**

Select the trigger source used to control the data acquisitions.

EXTErnal 1 - front panel external trigger input

EXTErnal 2 - rear panel external trigger input

FRAMe - uses the internal frame timer, which has been synchronized to the selected burst sync.

IF - internal IF envelope (video) trigger

LINE - internal power line frequency trigger

IMMEDIATE - the next data acquisition is immediately taken, capturing the signal asynchronously (also called Free Run).

RFBURst - wideband RF burst envelope trigger that has automatic level control for periodic burst signals.

Factory Preset: RFBURst if the RF Communications Hardware (option B7E) has been installed

EXTErnal, if option B7E has not been installed

FRAMe for 1xEV-DO

IF envelope (video) (iDEN, WiDEN)

Remarks: You must be in GSM, EDGE, Service, 1xEV-DO, iDen, WiDEN, or W-CDMA mode to use this command. Use INSTRUMENT:SElect to set the mode.

## MotoTalk Average Power (MT Avg Pwr) Measurement

Commands for querying the MotoTalk average power measurement results and for setting to the default values are found in the “MEASure Group of Commands” on page 138. The equivalent front panel keys for the parameters described in the following commands, are found under the **Meas Setup** key, after the **MT Avg Pwr** measurement has been selected from the **MEASURE** key menu.

### MotoTalk Average Power—Number Of Bursts Averaged

[ :SENSe ] :APOWer:AVERAge:COUNT <integer>

[ :SENSe ] :APOWer:AVERAge:COUNT?

Set the number of bursts that will be averaged. After the specified number of bursts (average counts), the averaging mode (terminal control) setting determines the averaging action.

Factory Preset: 20

Range: 1 to 1,000

Remarks: You must be in the iDEN mode to use this command. Use INSTRUMENT:SElect to set the mode.

Front Panel

Access: **Meas Setup, Avg Bursts**

### MotoTalk Average Power—Averaging State

[ :SENSe ] :APOWer:AVERAge [ :STATe ] OFF | ON | 0 | 1

[ :SENSe ] :APOWer:AVERAge [ :STATe ] ?

Turn averaging on or off.

Factory Preset: On

Remarks: You must be in the GSM mode to use this command. Use INSTRUMENT:SElect to set the mode.

Front Panel

Access: **Meas Setup, Avg Bursts**

### MotoTalk Average Power—Resolution BW

**[ :SENSE ] :APOWER :BANDwidth | BWIDth [ :RESolution ] <bandwidth>**

**[ :SENSe ] :APOWER :BANDwidth | BWIDth [ :RESolution ] ?**

Set the resolution BW. This is an advanced control that normally does not need to be changed. Setting this to a value other than the factory default, may cause invalid measurement results.

Factory Preset: 25.600 kHz

Range: 1 kHz to 5 MHz

Default Unit: Hz

Remarks: You must be in the iDEN mode to use this command.  
Use INSTRument:SElect to set the mode.

Front Panel

Access: Meas Setup, Advanced, Res BW

### MotoTalk Average Power—RBW Filter Type

**[ :SENSe ] :APOWER :BANDwidth | BWIDth [ :RESolution ] :TYPE  
FLATtop | GAUSSian**

**[ :SENSe ] :APOWER :BANDwidth | BWIDth [ :RESolution ] :TYPE?**

Select the type of resolution bandwidth filter. This is an advanced control that normally does not need to be changed. Setting this to a value other than the factory default, may cause invalid measurement results.

FLATtop - a filter with a flat amplitude response, which provides the best amplitude accuracy.

GAUSSian - a filter with Gaussian characteristics, which provides the best pulse response.

Factory Preset: GAUSSian

Remarks: You must be in the iDEN mode to use this command.  
Use INSTRument:SElect to set the mode.

Front Panel

Access: Meas Setup, Advanced, RBW Filter

### MotoTalk Average Power—Burst Identification Method

**[ :SENSe ] :APOWER :BIDMethod RFAmplitude | SWORD**

**[ :SENSe ] :APOWER :BIDMethod?**

Select the method of identifying normal (traffic) bursts.

RFAMplitude – the measurement uses the amplitude variation within a burst and the burst position to identify the type of burst.

SWORd – the measurement performs demodulation and use the sync word to identify the type of burst.

The **RF Amptd** method is faster than the **Sync Word** method. For either method to work well, the **Res BW** should not be set to more than 35 kHz.

Factory Preset: RFA

Remarks: You must be in the iDEN mode to use this command.  
Use INSTRument:SElect to set the mode.

Front Panel

Access: Meas Setup, Burst ID Method

### MotoTalk Average Power—Decimation Factor

```
[ :SENSe ] :APOWer:DECimation[:FACTOR] <integer>
```

```
[ :SENSe ] :APOWer:DECimation[:FACTOR] ?
```

Set the amount of data decimation done by the hardware and/or the firmware in order to decrease the number of acquired points in a long capture time. This is the amount of data that the measurement ignores. For example, if 4 is selected, three out of every four data points will be thrown away. So every 4th data point will be kept.

When Decimation State is Auto, the Decimation Factor is set to zero (0). Zero indicates auto decimation (determined by measurement). 1-4 indicates manually controlled decimation factor.

This is an advanced control that normally does not need to be changed. Setting this to a value other than the factory default, may cause invalid measurement results.

Factory Preset  
and \*RST: 0

Range: 0 to 4

Remarks: You must be in the iDEN mode to use this command.  
Use INSTRument:SElect to set the mode.

Front Panel

Access: Meas Setup, Advanced, Decimation

### MotoTalk Average Power—Decimation State

```
[ :SENSe ] :APOWer:DECimation:STATE OFF|ON|0|1
```

```
[ :SENSe ] :APOWer:DECimation:STATE?
```

Sets the decimation function on or off. This is an advanced control that normally does not need to be changed. Setting this to a value other than the factory default, may cause invalid measurement results.

Select auto (default value) or manual (user entered value) to set the resolution bandwidth.

Factory Preset  
and \*RST: On

Remarks: You must be in the iDEN mode to use this command.  
Use INSTRument:SElect to set the mode.

Front Panel  
Access: Meas Setup, Advanced, Decimation

### MotoTalk Average Power—Measurement Method

**[ :SENSe ] :APOWer :MEASure BURst | GATED | GBURst**

**[ :SENSe ] :APOWer :MEASure?**

Sets the measurement method to be used.

**BURst** - When **Meas Method** is set to **Burst**, the measurement acquires **Avg Bursts** number of slots, search all the traffic burst in the captured data, compute the average power of each traffic burst. If the number of traffic bursts is less than the **Avg Bursts** (there might be preamble or sync bursts in the captured data), the measurement will acquire more data, and repeat the process until the total number of traffic bursts reaches the average count. The average, maximum, and minimum of the average burst power are also reported.

**GATED** - When **Meas Method** is set to **Gated**, the measurement captures **Gated Time** number of slots, and computes the average power of the entire data record.

**GBURst** - When **Meas Method** is set to **Gated & Burst**, the measurement captures **Gated Time** number of slots, computes the average power of the entire data record, then finds all the traffic bursts in the captured data, computes average power of each traffic bursts. The average, maximum, and minimum of the average traffic burst power are also reported.

Factory Preset: BURst

Front Panel  
Access: Meas Setup, Meas Method

### MotoTalk Average Power—Gated (Sweep) Time

**[ :SENSe ] :APOWer :SWEep :TIME <integer>**

**[ :SENSe ] :APOWer :SWEep :TIME?**

Set the number of slots which are used in each data acquisition. Each slot is 90 ms.

Factory Preset: 20

Range: 1 to 200 time slots

Remarks: You must be in the iDEN mode to use this command.  
Use INSTRument:SElect to set the mode.

Front Panel

Access: **Meas Setup, Gated Time**

### MotoTalk Average Power—Trigger Source

**[ :SENSe ] :APOWer :TRIGger :SOURce**

**IMMEDIATE | RFBurst | VIDEo | EXTernal [1] | EXTernal2**

**[ :SENSe ] :APOWer :TRIGger :SOURce?**

Select the trigger source used to control the data acquisitions.

Set the trigger delay when using an external trigger. Set the trigger value to zero (0) seconds to turn off the delay.

IMMEDIATE – the next data acquisition is immediately taken, capturing the signal asynchronously (also called free run)

RFBurst – wideband RF burst envelope trigger that has automatic level control for periodic burst signals

VIDEo - an internal IF envelope trigger. It triggers on an absolute threshold level of the signal passed by the IF.

EXT or EXT1 is the front panel trigger input

EXT2 is the rear panel trigger input

Factory Preset: RFBurst

Front Panel

Access: **Meas Setup, Trig Source**

### MotoTalk Transient Error Vector Magnitude (MT Trans EVM) Measurement

Commands for querying the MotoTalk transient error vector magnitude measurement results and for setting to the default values are found in the “MEASure Group of Commands” on page 138. The equivalent front



panel keys for the parameters described in the following commands, are found under the **Meas Setup** key, after the **MT Trans EVM** measurement has been selected from the **MEASURE** key menu.

### MotoTalk Transient Error Vector Magnitude—Frequency Hopping Delta Factor

**[ :SENSe ] :TEVM:FOfFset <freq>**

**[ :SENSe ] :TEVM:FOfFset?**

Set the frequency hopping delta or offset factor.

Factory Preset: 0.0

Range: 0.0 kHz to 1.00000 MHz

Remarks: You must be in the iDEN mode to use this command.  
Use INSTRument:SElect to set the mode.

Front Panel

Access: **Meas Setup, Hop Freq Ofst**

### MotoTalk Transient Error Vector Magnitude—Trigger Source

**[ :SENSe ] :TEVM:TRIGger:SOURce**

**IMMediate | RFBurst | EXTerna1 [1] | EXTerna12**

**[ :SENSe ] :TEVM:TRIGger:SOURce?**

Select the trigger source used to control the data acquisitions.

IMMediate – the next data acquisition is immediately taken, capturing the signal asynchronously (also called free run)

RFBurst – wideband RF burst envelope trigger that has automatic level control for periodic burst signals

EXT or EXT1 is the front panel trigger input

EXT2 is the rear panel trigger input

Factory Preset: EXT1

Front Panel

Access: **Meas Setup, Trig Source**

### MotoTalk Transient Error Vector Magnitude—RBW Filter Type

**[ :SENSe ] :TEVM:BANDwidth | BWIDth:RESolution:TYPE**

**FLATtop | GAUSSian**

**[ :SENSe ] :TEVM:BANDwidth | BWIDth:RESolution:TYPE?**

Select the type of resolution bandwidth filter. This is an advanced

control that normally does not need to be changed. Setting this to a value other than the factory default, may cause invalid measurement results.

FLATtop - a filter with a flat amplitude response, which provides the best amplitude accuracy.

GAUSSian - a filter with Gaussian characteristics, which provides the best pulse response.

Factory Preset: GAUSSian

Remarks: You must be in the iDEN mode to use this command.  
Use INSTRument:SElect to set the mode.

Front Panel

Access: Meas Setup, Advanced, RBW Filter

### MotoTalk Transient Error Vector Magnitude—Resolution BW

**[ :SENSe ] :TEVM: BANDwidth | BWIDth [ :RESolution ] ?**

Set the resolution BW. This is an advanced control that normally does not need to be changed. Setting this to a value other than the factory default, may cause invalid measurement results.

Factory Preset: 25.600 kHz

Range: 1.000 kHz to 1.00000 MHz

Default Unit: Hz

Remarks: You must be in the iDEN mode to use this command.  
Use INSTRument:SElect to set the mode.

Front Panel

Access: Meas Setup, Advanced, Res BW

### MotoTalk Transient Error Vector Magnitude—Decimation Factor

**[ :SENSe ] :TEVM: DECimation [ :FACTor ] <integer>**

**[ :SENSe ] :TEVM: DECimation [ :FACTor ] ?**

Set the amount of data decimation done by the hardware and/or the firmware in order to decrease the number of acquired points in a long capture time. This is the amount of data that the measurement ignores. For example, if 4 is selected, three out of every four data points will be thrown away. So every 4th data point will be kept.

When Decimation State is Auto, the Decimation Factor is set to zero (0). Zero indicates auto decimation (determined by measurement). 1-4

indicates manually controlled decimation factor.

This is an advanced control that normally does not need to be changed. Setting this to a value other than the factory default, may cause invalid measurement results.

Factory Preset  
and \*RST: 0

Range: 0 to 4

Remarks: You must be in the iDEN mode to use this command.  
Use INSTRUMENT:SELEct to set the mode.

Front Panel  
Access: Meas Setup, Advanced, Decimation

### MotoTalk Transient Error Vector Magnitude—Decimation State

**[ :SENSE ] :TEVM:DECimation:STATE OFF | ON | 0 | 1**

**[ :SENSE ] :TEVM:DECimation:STATE?**

Set the decimation function on or off. This is an advanced control that normally does not need to be changed. Setting this to a value other than the factory default, may cause invalid measurement results.

Factory Preset  
and \*RST: On

Remarks: You must be in the iDEN mode to use this command.  
Use INSTRUMENT:SELEct to set the mode.

Front Panel  
Access: Meas Setup, Advanced, Decimation

### RF Port Input Attenuation

**[ :SENSE ] :POWER [ :RF ] :ATTenuation <rel\_power>**

**[ :SENSE ] :POWER [ :RF ] :ATTenuation?**

Set the RF input attenuator. This value is set at its auto value if input attenuation is set to auto.

Factory Preset  
and \*RST: 0 dB  
12.0 dB for iDEN

Range: 0 to 40 dB

Default Unit: dB

Remarks: You must be in the Service, cdmaOne, GSM, NADC, PDC, cdma2000, W-CDMA, iDEN, WiDEN mode to use this command. Use INSTRUMENT:SELEct to set the mode.

Front Panel

Access: **Input, Input Atten**

## RF Port Power Range Maximum Total Power

**[ :SENSe ] :POWer [ :RF ] :RANge [ :UPPer ] <power>**

**[ :SENSe ] :POWer [ :RF ] :RANge [ :UPPer ] ?**

Set the maximum expected total power level at the radio unit under test. This value is ignored if RF port power range is set to auto. External attenuation required above 30 dBm.

Factory Preset

and \*RST: -15.0 dBm

Range:

-100 to 80 dBm for GSM

-100 to 27.7 dBm for cdmaOne, iDEN

-200 to 50 dBm for NADC, PDC

-200 to 100 dBm for cdma2000, W-CDMA

Default Unit: dBm

Remarks:

Global to the current mode. This is coupled to the RF input attenuation

You must be in the Service, cdmaOne, GSM, NADC, PDC, cdma2000, W-CDMA, iDEN, WiDEN mode to use this command. Use INSTRUMENT:SELEct to set the mode.

Front Panel

Access: **Input, Max Total Pwr (at UUT)**

## Radio Setup

### Radio Carrier Configuration

```
[ :SENSE ] :RADIO:CARRIER [ :TYPE ] AUTO | I25 | I50 | O50 | I75 | I100
```

```
[ :SENSE ] :RADIO:CARRIER [ :TYPE ] ?
```

Select the method used to determine the configuration of the carrier being measured. If you set the carrier configuration type to 'AUTO', the carrier configuration is detected automatically. To detect the carrier configuration, the instrument captures a signal with a wide bandwidth, covering 100 kHz. When you select one of the other configuration options, the carrier configuration is predefined. In this case, the instrument captures a signal with a bandwidth only covering the predefined carrier configuration. Selecting one of the predefined configuration options will reduce measurement time.

Factory Preset: AUTO

Saved State: Saved in instrument state

Range: Auto | 25kHz | 50kHz | 50kHz outer | 75kHz | 100kHz

Remarks: You must be in the WiDEN mode to use this command.  
Use INSTRUMENT:SELEct to set the mode.

Global to the current mode.

History: Version A.07.05 or later

Front Panel

Access: **Mode Setup, Radio**

### Radio Carrier Configuration, Actual (Remote Command Only)

```
[ :SENSE ] :RADIO:CARRIER [ :TYPE ] :ACTual?
```

At the start of measurements (that is when you select a measurement, press **Restart**, or changing some parameters), the instrument detects the actual carrier configuration. The detected carrier configuration is returned by this query. This query is useful particularly when Carrier Config is set to AUTO. When Carrier Config is set to predefined one, this parameter is equal to the predefined. For more information on Carrier Config, refer to [“Radio Carrier Configuration” on page 213](#)

Saved State: Saved in instrument state

Remarks: You must be in the WiDEN mode to use this command.  
Use INSTRUMENT:SELEct to set the mode.

Global to the current mode.

History: Version A.07.05 or later

Front Panel

Access: **No front panel access**

### Radio Carrier Multiple

**[[:SENSe]:RADio:CARRier:NUMBER SINGLE|MULTiple**

**[[:SENSe]:RADio:CARRier:NUMBER?**

Select if single or multiple carriers are present on the output of the base station under test. This enables/disables a software filter for the rho and code domain power measurements.

Factory Preset  
and \*RST: Single

Remarks: You must be in the iDEN mode to use this command.  
Use INSTRument:SElect to set the mode.

Front Panel  
Access: **Mode Setup, Demod, RF Carrier**

### Radio Color Code

**[[:SENSe]:RADio:CCODE <integer>**

**[[:SENSe]:RADio:CCODE?**

Set the Color Code (0-95) which is used to define synchronization and pilot symbols in Split 3:1 and Enhanced 6:1.

Factory Preset: 39

Remarks: You must be in iDEN, WiDEN mode to use this  
command. Use INSTRument:SElect to set the mode.

Front Panel  
Access: **Mode Setup, Radio, Color Code**

### Radio Device Under Test

**[[:SENSe]:RADio:DEVice INBound|OUTBound**

**[[:SENSe]:RADio:DEVice?**

Select the type of radio device to be tested. If you are testing a base station, it must be put into the test mode to transmit known bit patterns.

Outbound – Base station transmitter test

Inbound – Mobile station transmitter test

Factory Preset

and \*RST: INBound

Remarks: You must be in the iDEN mode to use this command.  
Use INSTRument:SElect to set the mode.  
This command is *not* available in the WiDEN mode.  
Global to current mode.

Front Panel  
Access: **Mode Setup, Radio, Device**

## Radio Format (Standard)

```
[ :SENSe ] :RADIo:FORMat M16QAM|M64QAM|DMCA|DJSMr
```

```
[ :SENSe ] :RADIo:FORMat?
```

Select the format that testing will be compliant with when measurements are made.

M16QAM, is the standard iDEN format defined by Motorola

M64QAM, is the standard iDEN format defined by Motorola

DMCA, is the standard iDEN format defined by Motorola

DJSMR, is Japanese standard format that is based on the ARIB RCR-32A standard

Factory Preset

and \*RST: M16QAM

Remarks: You must be in the iDEN mode to use this command.  
Use INSTRUMENT:SELEct to set the mode.

This command is *not* available in the WiDEN mode.

History: Version A.03.00 or later

Front Panel

Access: **Mode Setup, Radio, Format**

## Radio Inbound Slot Setup

```
[ :SENSe ] :RADIo:SLOT:INBound TCHFull|TCHS31|TCHS31T|TCHE61
```

```
[ :SENSe ] :RADIo:SLOT:INBound?
```

Select the inbound signal slot format Idle (including Pilot and MAC) or Active (including Pilot, MAC, and Data). Define the reference point of the mask timing.

TCHFull - Legacy Full Reserved Access slot defined by Motorola. Set to the idle slot that includes the Pilot and MAC channels, of which waveform is bursted.

TCHS31 - Split 3:1 Reserved Access slot (with pseudo training) defined by Motorola. Set to the idle slot that includes the Pilot and MAC channels, of which waveform is bursted.

TCHS31T - Split 3:1 Reserved Access with Training defined by Motorola. Set to the idle slot that includes the Pilot and MAC channels, of which waveform is bursted.

TCHE61 - Enhanced 6:1 Full Reserved Access Slot format defined by Motorola. Set to the idle slot that includes the Pilot and MAC channels, of which waveform is bursted.



Factory Preset: TCHFull

Remarks: You must be in iDEN mode to use this command. Use INSTRUMENT:SELEct to set the mode.

This command is *not* available in the WiDEN mode.

Front Panel

Access: **Mode Setup, Radio, Inbound Slot**

### Radio Outbound Slot Setup

`[ :SENSe ] :RADIo :SLOT :OUTBound TCHFull | TCHS31 | TCHS31T | TCHE61`

`[ :SENSe ] :RADIo :SLOT :OUTBound?`

Select the outbound signal slot format Idle (including Pilot and MAC) or Active (including Pilot, MAC, and Data). Define the reference point of the mask timing.

TCHFull - Legacy Full Reserved Access slot defined by Motorola. Set to the idle slot that includes the Pilot and MAC channels, of which waveform is bursted.

TCHS31 - Split 3:1 Reserved Access slot (with pseudo training) defined by Motorola. Set to the idle slot that includes the Pilot and MAC channels, of which waveform is bursted.

TCHS31T - Split 3:1 Reserved Access with Training defined by Motorola. Set to the idle slot that includes the Pilot and MAC channels, of which waveform is bursted.

TCHE61 - Enhanced 6:1 Full Reserved Access Slot format defined by Motorola. Set to the idle slot that includes the Pilot and MAC channels, of which waveform is bursted.

Factory Preset: TCHFull

Remarks: You must be in iDEN mode to use this command. Use INSTRUMENT:SELEct to set the mode.

This command is *not* available in the WiDEN mode.

Front Panel

Access: **Mode Setup, Radio, Inbound Slot**

### Spectrum (Frequency-Domain) Measurement

Commands for querying the spectrum measurement results and for setting to the default values are found in the [“MEASure Group of Commands” on page 138](#). The equivalent front panel keys for the parameters described in the following commands, are found under the

**Meas Setup** key, after the **Spectrum (Freq Domain)** measurement has been selected from the **MEASURE** key menu.

### Spectrum—Data Acquisition Packing

```
[ :SENSe ] :SPECTrum:ACQuisition:PACKing  
AUTO | LONG | MEDium | SHORt
```

```
[ :SENSe ] :SPECTrum:ACQuisition:PACKing?
```

Select the amount of data acquisition packing. This is an advanced control that normally does not need to be changed.

Factory Preset  
and \*RST: Auto

Remarks: To use this command, the appropriate mode should be selected with INSTRUMENT:SElect.

Back door for all meas DIAG:ACQ:PACKmode]

### Spectrum—ADC Dither

```
[ :SENSe ] :SPECTrum:ADC:DITHer [ :STATe ] AUTO | ON | OFF | 2 | 1 | 0
```

```
[ :SENSe ] :SPECTrum:ADC:DITHer [ :STATe ] ?
```

Turn the ADC dither on or off. This is an advanced control that normally does not need to be changed.

Factory Preset  
and \*RST: Auto

Remarks: To use this command, the appropriate mode should be selected with INSTRUMENT:SElect.

### Spectrum—ADC Range

```
[ :SENSe ] :SPECTrum:ADC:RANGe  
AUTO | APEak | APLOCK | M6 | P0 | P6 | P12 | P18 | P24 | NONE
```

```
[ :SENSe ] :SPECTrum:ADC:RANGe?
```

Select the range for the gain-ranging that is done in front of the ADC. This is an advanced control that normally does not need to be changed. Auto peak ranging is the default for this measurement. If you are measuring a CW signal please see the description below.

- Auto - automatic range

For FFT spectrums - auto ranging should not be not be used. An exception to this would be if you know that your signal is “bursty”. Then you might use auto to maximize the time domain dynamic range as long as you are not very interested in the FFT data.

- Auto Peak - automatically peak the range

For CW signals, the default of auto-peak ranging can be used, but a better FFT measurement of the signal can be made by selecting one of the manual ranges that are available: M6, P0 - P24.

Auto peaking can cause the ADC range gain to move monotonically down during the data capture. This movement should have negligible effect on the FFT spectrum, but selecting a manual range removes this possibility. Note that if the CW signal being measured is close to the auto-ranging threshold, the noise floor may shift as much as 6 dB from sweep to sweep.

- Auto Peak Lock - automatically peak lock the range

For CW signals, auto-peak lock ranging may be used. It will find the best ADC measurement range for this particular signal and will not move the range as auto-peak can. Note that if the CW signal being measured is close to the auto-ranging threshold, the noise floor may shift as much as 6 dB from sweep to sweep.

For “bursty” signals, auto-peak lock ranging should not be used. The measurement will fail to operate, since the wrong (locked) ADC range will be chosen often and overloads will occur in the ADC.

- M6 - manually selects an ADC range that subtracts 6 dB of fixed gain across the range. Manual ranging is best for CW signals.
- P0 to 24 - manually selects ADC ranges that add 0 to 24 dB of fixed gain across the range. Manual ranging is best for CW signals.
- None - turns off any auto-ranging without making any changes to the current setting.

Factory Preset  
and \*RST: Auto peak

Remarks: To use this command, the appropriate mode should be selected with INSTRUMENT:SElect.

Backdoor for all meas DIAG:ADC:RANGe

### Spectrum—Average Clear

**[ :SENSe ] :SPECTrum:AVERAge:CLEAr**

The average data is cleared and the average counter is reset.

Remarks: To use this command, the appropriate mode should be selected with INSTRUMENT:SElect.

### Spectrum—Number of Averages

**[ :SENSe ] :SPECTrum:AVERAge:COUnT <integer>**

**[ :SENSe ] :SPECTrum:AVERAge:COUnT?**

Set the number of ‘sweeps’ that will be averaged. After the specified

number of 'sweeps' (average counts), the averaging mode (terminal control) setting determines the averaging action.

Factory Preset  
and \*RST: 25

Range: 1 to 10,000

Remarks: To use this command, the appropriate mode should be selected with INSTRument:SElect.

### Spectrum—Averaging State

**[ :SENSe ] :SPECTrum:AVERAge [ :STATe ] OFF | ON | 0 | 1**

**[ :SENSe ] :SPECTrum:AVERAge [ :STATe ] ?**

Turn averaging on or off.

Factory Preset  
and \*RST: On

Remarks: To use this command, the appropriate mode should be selected with INSTRument:SElect.

### Spectrum—Averaging Mode

**[ :SENSe ] :SPECTrum:AVERAge:TCONTRol EXPonential | REPeat**

**[ :SENSe ] :SPECTrum:AVERAge:TCONTRol?**

Select the type of termination control used for the averaging function. This determines the averaging action after the specified number of 'sweeps' (average count) is reached.

Exponential - Each successive data acquisition after the average count is reached, is exponentially weighted and combined with the existing average.

Repeat - After reaching the average count, the averaging is reset and a new average is started.

Factory Preset  
and \*RST: Exponential

Remarks: To use this command, the appropriate mode should be selected with INSTRument:SElect.

Exponential means:

$$\text{Avg}_N = \frac{\text{Avg}_{N-1}}{N}(N-1) + \frac{\text{Next Measurement}}{N}$$

Repeat means: reset to zero when N is reached.

Exponential means: continue averaging after N is

reached, but keep N fixed.

### Spectrum—Averaging Type

**[ :SENSE ] :SPECTrum:AVERAge:TYPE**  
**LOG | MAXimum | MINimum | RMS | SCALar**

**[ :SENSe ] :SPECTrum:AVERAge:TYPE?**

Select the type of averaging.

Log – The log of the power is averaged. (This is also known as video averaging.)

Maximum – The maximum values are retained.

Minimum – The minimum values are retained.

RMS – The power is averaged, providing the rms of the voltage.

Scalar – The voltage is averaged.

Factory Preset

and \*RST:      Log

Remarks:      To use this command, the appropriate mode should be selected with INSTRument:SElect.

### Spectrum—Pre-ADC Bandpass Filter

**[ :SENSe ] :SPECTrum:Bandwidth | BWIDth:PADC OFF | ON | 0 | 1**

**[ :SENSe ] :SPECTrum:Bandwidth | BWIDth:PADC?**

Turn the pre-ADC bandpass filter on or off. This is an advanced control that normally does not need to be changed.

Remarks:      To use this command, the appropriate mode should be selected with INSTRument:SElect.

### Spectrum—Pre-FFT BW Auto

**[ :SENSe ] :SPECTrum:Bandwidth | BWIDth:PFFT:AUTO OFF | ON | 0 | 1**

**[ :SENSe ] :SPECTrum:Bandwidth | BWIDth:PFFT:AUTO?**

Select auto or manual control of the pre-FFT BW. This is an advanced control that normally does not need to be changed.

Auto - couples the pre-FFT BW to the frequency span.

Manual - the pre-FFT BW is uncoupled from the frequency span.

Remarks:      To use this command, the appropriate mode should be selected with INSTRument:SElect.

### Spectrum—Pre-FFT BW

**[ :SENSe ] :SPECTrum:Bandwidth | BWIDth:PFFT [ :SIZE ] <freq>**

**[[:SENSe]:SPECTrum:BAWdwidth|BWIDth:PPFT[:SIZE]?**

Set the pre-FFT bandwidth. This is an advanced control that normally does not need to be changed.

Frequency span, resolution bandwidth, and the pre-FFT bandwidth settings are normally coupled. If you are not auto-coupled, there can be combinations of these settings that are not valid.

Factory Preset

and \*RST: 1.55 MHz  
1.25 MHz for cdmaOne  
155 kHz, for iDEN mode

Range: 1 Hz to 10 MHz

Remarks: To use this command, the appropriate mode should be selected with INSTRument:SElect.

### Spectrum—Pre-FFT BW Filter Type

**[[:SENSe]:SPECTrum:BAWdwidth|BWIDth:PPFT:TYPE FLAT|GAUSSian  
[:SENSe]:SPECTrum:BAWdwidth|BWIDth:PPFT:TYPE?**

Select the type of pre-FFT filter that is used. This is an advanced control that normally does not need to be changed.

Flat top- a filter with a flat amplitude response, which provides the best amplitude accuracy.

Gaussian - a filter with Gaussian characteristics, which provides the best pulse response.

Factory Preset

and \*RST: Flat top

Remarks: To use this command, the appropriate mode should be selected with INSTRument:SElect.

### Spectrum—Resolution BW

**[[:SENSe]:SPECTrum:BAWdwidth|BWIDth[:RESolution] <freq>  
[:SENSe]:SPECTrum:BAWdwidth|BWIDth[:RESolution]?**

Set the resolution bandwidth for the FFT. This is the bandwidth used for resolving the FFT measurement. It is not the pre-FFT bandwidth. This value is ignored if the function is auto-coupled.

Frequency span, resolution bandwidth, and the pre-FFT bandwidth settings are normally coupled. If you are not auto-coupled, there can be combinations of these settings that are not valid.

Factory Preset

and \*RST: 20 kHz

250 Hz, for iDEN mode

Range: 0.10 Hz to 3 MHz

Remarks: To use this command, the appropriate mode should be selected with INSTRUMENT:SElect.

### Spectrum—Resolution BW Auto

**[ :SENSE ] :SPECTrum:BA NDwidth | BWIDth [ :RESolution ] :AUTO  
OFF | ON | 0 | 1**

**[ :SENSe ] :SPECTrum:BA NDwidth | BWIDth [ :RESolution ] :AUTO?**

Select auto or manual control of the resolution BW. The automatic mode couples the resolution bandwidth setting to the frequency span.

Factory Preset  
and \*RST: On

Off, for iDEN mode

Remarks: To use this command, the appropriate mode should be selected with INSTRUMENT:SElect.

### Decimation of Spectrum Display

**[ :SENSE ] :SPECTrum:DECimate [ :FACTOR ] <integer>**

**[ :SENSe ] :SPECTrum:DECimate [ :FACTOR ] ?**

Set the amount of data decimation done by the hardware and/or the software. Decimation by 3 keeps every third sample, throwing away the two in between. Similarly, decimation by 5 keeps every fifth sample, throwing away the four in between.

Using zero (0) decimation selects the automatic mode. The measurement will then automatically choose decimation by “1” or “2” as is appropriate for the bandwidth being used. This is an advanced control that normally does not need to be changed.

Factory Preset  
and \*RST: 0

Range: 0 to 1000, where 0 sets the function to automatic

Remarks: To use this command, the appropriate mode should be selected with INSTRUMENT:SElect.

Decimation of 1-4 uses Natasha hardware. Decimation. Beyond 4 uses a combination of software and hardware decimation.

History: Version A.02.00 or later

### Spectrum—FFT Length

**[ :SENSe ] :SPECTrum:FFT:LENGth <integer>**

**[ :SENSe ] :SPECTrum:FFT:LENGth?**

Set the FFT length. This value is only used if length control is set to manual. The value must be greater than or equal to the window length value. Any amount greater than the window length is implemented by zero-padding. This is an advanced control that normally does not need to be changed.

Factory Preset

and \*RST: 4096

32768, for iDEN mode

Range: 8 to 1,048,576

Remarks: To use this command, the appropriate mode should be selected with INSTRUMENT:SElect.

History: Short form changed from LENGth to LENGth, A.03.00

### Spectrum—FFT Length Auto

**[ :SENSe ] :SPECTrum:FFT:LENGth:AUTO OFF | ON | 0 | 1**

**[ :SENSe ] :SPECTrum:FFT:LENGth:AUTO?**

Select auto or manual control of the FFT and window lengths.

This is an advanced control that normally does not need to be changed.

Auto - the window lengths are coupled to resolution bandwidth, window type (FFT), pre-FFT bandwidth (sample rate) and SENSE:SPECTrum:FFT:RBWPoints.

Manual - lets you set SENSE:SPECTrum:FFT:LENGth and SENSE:SPECTrum:FFT:WINDow:LENGth.

Factory Preset

and \*RST: Auto

Remarks: To use this command, the appropriate mode should be selected with INSTRUMENT:SElect.

History: Short form changed from LENGth to LENGth, A.03.00

### Spectrum—FFT Minimum Points in Resolution BW

**[ :SENSe ] :SPECTrum:FFT:RBWPoints <real>**

**[ :SENSe ] :SPECTrum:FFT:RBWPoints?**

Set the minimum number of data points that will be used inside the resolution bandwidth. The value is ignored if length control is set to manual. This is an advanced control that normally does not need to be



changed.

Factory Preset  
and \*RST: 1.30

Range: 0.1 to 100

Remarks: To use this command, the appropriate mode should be selected with INSTRUMENT:SElect.

## Spectrum—Window Length

**[ :SENSe ] :SPECTrum:FFT:WINDow:LENGth <integer>**

**[ :SENSe ] :SPECTrum:FFT:WINDow:LENGth?**

Set the FFT window length. This value is only used if length control is set to manual. This is an advanced control that normally does not need to be changed.

Factory Preset

and \*RST: 706

5648, for iDEN mode

Range: 8 to 1,048,576

Remarks: To use this command, the appropriate mode should be selected with INSTRument:SElect.

History: Short form changed from LENGth to LENGth, A.03.00

## Spectrum—FFT Window

**[ :SENSe ] :SPECTrum:FFT:WINDow[ :TYPE]**

**BH4Tap | BLACkman | FLATtop | GAUSSian | HAMMING | HANNing | KB70 | KB90 | KB110 | UNIFORM**

**[ :SENSe ] :SPECTrum:FFT:WINDow[ :TYPE] ?**

Select the FFT window type.

BH4Tap - Blackman Harris with 4 taps

Blackman - Blackman

Flat Top - flat top, the default (for high amplitude accuracy)

Gaussian - Gaussian with alpha of 3.5

Hamming - Hamming

Hanning - Hanning

KB70, 90, and 110 - Kaiser Bessel with sidelobes at -70, -90, or -110 dBc

Uniform - no window is used. (This is the unity response.)

Factory Preset

and \*RST: Flat top

Remarks: This selection affects the acquisition point quantity and the FFT size, based on the resolution bandwidth selected.

To use this command, the appropriate mode should be selected with INSTRument:SElect.

## Spectrum—Frequency Span

**[ :SENSE ] :SPECTrum:FREQUency:SPAN <freq>**

**[ :SENSe ] :SPECTrum:FREQUency:SPAN?**

Set the frequency span to be measured.

Factory Preset

and \*RST: 1 MHz

100 kHz for iDEN mode

Range: 10 Hz to 10 MHz (15 MHz when Service mode is selected)

Default Unit: Hz

Remarks: The actual measured span will generally be slightly wider due to the finite resolution of the FFT.

To use this command, the appropriate mode should be selected with INSTRument:SElect.

## Spectrum—Trigger Source

**[ :SENSe ] :SPECTrum:TRIGger:SOURce EXTErnal [1] | EXTErnal 2 | FRAME | IF | LINE | IMMEDIATE | RFBurst**

**[ :SENSe ] :SPECTrum:TRIGger:SOURce?**

Select the trigger source used to control the data acquisitions.

External 1 - front panel external trigger input

External 2 - rear panel external trigger input

Frame - internal frame timer from front panel input

IF - internal IF envelope (video) trigger

Line - internal line trigger

Immediate - the next data acquisition is immediately taken (also called free run)

RF Burst - internal wideband RF burst envelope trigger that has automatic level control for periodic burst signals

Factory Preset

and \*RST: Immediate (free run)

RF burst, for GSM, iDEN mode

Remarks: To use this command, the appropriate mode should be selected with INSTRument:SElect.

## Burst Sync Delay

**[[:SENSe]:SYNC:BURSt:DELay <time>**

**[[:SENSe]:SYNC:BURSt:DELay?**

Set the delay for the burst measurement position from the reference position that is determined by sync word or the burst rising/falling edges.

Factory Preset

and \*RST: 0 sec

Range: -500 ms to 500 ms

Default Unit: seconds

Remarks: You must be in the iDEN, NADC or PDC mode to use this command. Use INSTRument:SElect to set the mode.

## Burst Search Threshold

**[[:SENSe]:SYNC:STHreshold <rel\_power>**

**[[:SENSe]:SYNC:STHreshold?**

Set the power threshold, relative to the peak power, that is used to determine the burst rising edge and falling edge.

Factory Preset

and \*RST: -30 dB

Range: -200 to -0.01 dB

Default Unit: dB

Remarks: You must be in the iDEN, NADC or PDC mode to use this command. Use INSTRument:SElect to set the mode.

Front Panel

Access: **Mode Setup, Trigger, Burst Search Threshold**

## Waveform (Time-Domain) Measurement

Commands for querying the waveform measurement results and for setting to the default values are found in the “[MEASure Group of Commands](#)” on page 138. The equivalent front panel keys for the parameters described in the following commands, are found under the **Meas Setup** key, after the **Waveform (Time Domain)** measurement has been selected from the **MEASURE** key menu.

### Waveform—Pre-ADC Bandpass Filter

```
[ :SENSe] :WAVEform:ADC:FILTer: [:STATe] OFF | ON | 0 | 1
```

```
[ :SENSe] :WAVEform:ADC:FILTer: [:STATe] ?
```

Turn the pre-ADC bandpass filter on or off. This is an Advanced control that normally does not need to be changed.

Preset: Off

Remarks: To use this command, the appropriate mode should be selected with INSTRument:SElect.

### Waveform—ADC Range

```
[ :SENSe] :WAVEform:ADC:RANGe
```

```
AUTO | APEak | APLock | GROund | M6 | P0 | P6 | P12 | P18 | P24 |
```

```
[ :SENSe] :WAVEform:ADC:RANGe?
```

Select the range for the gain-ranging that is done in front of the ADC. This is an Advanced control that normally does not need to be changed.

Auto - automatic range

Auto Peak - automatically peak the range

Auto Peak Lock - automatically peak lock the range

Ground - ground

M6 - subtracts 6 dB of fixed gain across the range

P0 to 24 - adds 0 to 24 dB of fixed gain across the range

Factory Preset  
and \*RST: Auto

Remarks: To use this command, the appropriate mode should be selected with INSTRument:SElect.

### Waveform—Number of Averages

**[ :SENSe ] :WAVeform:AVERAge:COUNT <integer>**

**[ :SENSe ] :WAVeform:AVERAge:COUNT?**

Set the number of sweeps that will be averaged. After the specified number of sweeps (average counts), the averaging mode (terminal control) setting determines the averaging action.

Factory Preset

and \*RST: 10

Range: 1 to 10,000

Remarks: To use this command, the appropriate mode should be selected with INSTRument:SElect.

### Waveform—Averaging State

**[ :SENSe ] :WAVeform:AVERAge [ :STATe ] OFF | ON | 0 | 1**

**[ :SENSe ] :WAVeform:AVERAge [ :STATe ] ?**

Turn averaging on or off.

Factory Preset

and \*RST: Off

Remarks: To use this command, the appropriate mode should be selected with INSTRument:SElect.

### Waveform—Averaging Mode

**[ :SENSe ] :WAVeform:AVERAge:TCONTrOl EXPONential | REPeat**

**[ :SENSe ] :WAVeform:AVERAge:TCONTrOl?**

Select the type of termination control used for the averaging function. This determines the averaging action after the specified number of 'sweeps' (average count) is reached.

Exponential - Each successive data acquisition after the average count is reached, is exponentially weighted and combined with the existing average.

Repeat - After reaching the average count, the averaging is reset and a new average is started.

Factory Preset

and \*RST: Exponential

Remarks: To use this command, the appropriate mode should be selected with INSTRument:SElect.

$$\text{Avg}_N = \frac{\text{Avg}_{N-1}(N-1) + \text{Next Measurement}}{N}$$

Repeat means: reset to zero when N is reached.

Exponential means:

### Waveform—Averaging Type

**[ :SENSE ] :WAVEform:AVERAge:TYPE**  
**LOG | MAXimum | MINimum | RMS | SCALar**

**[ :SENSE ] :WAVEform:AVERAge:TYPE?**

Select the type of averaging.

Log - The log of the power is averaged. (This is also known as video averaging.)

Maximum - The maximum values are retained.

Minimum - The minimum values are retained.

RMS - The power is averaged, providing the rms of the voltage.

Factory Preset  
and \*RST: RMS

Remarks: To use this command, the appropriate mode should be selected with INSTRUMENT:SElect.

### Waveform—Resolution BW

**[ :SENSE ] :WAVEform:BANDwidth|BWIDth[:RESolution] <freq>**

**[ :SENSE ] :WAVEform:BANDwidth|BWIDth[:RESolution]?**

Set the resolution bandwidth. This value is ignored if the function is auto-coupled.

Factory Preset  
and \*RST: 100 kHz, for NADC, PDC, cdma2000, W-CDMA,  
basic, service mode  
500 kHz, for GSM mode  
2 MHz. for cdmaOne

Range: 1 kHz to 5 MHz

Remarks: To use this command, the appropriate mode should be selected with INSTRUMENT:SElect.

## Waveform—Resolution BW Filter Type

```
[ :SENSe ] :WAVeform: BANDwidth | BWIDth [ :RESolution ] :TYPE  
FLATtop | GAUSSian
```

```
[ :SENSe ] :WAVeform: BANDwidth | BWIDth [ :RESolution ] :TYPE?
```

Select the type of Resolution BW filter that is used. This is an Advanced control that normally does not need to be changed.

Flat top - a filter with a flat amplitude response, which provides the best amplitude accuracy.

Gaussian - a filter with Gaussian characteristics, which provides the best pulse response.

Factory Preset  
and \*RST: Gaussian

Remarks: To use this command, the appropriate mode should be selected with INSTRUMENT:SElect.

## Decimation of Waveform Display

```
[ :SENSe ] :WAVeform: DECimate [ :FACTor ] <integer>
```

```
[ :SENSe ] :WAVeform: DECimate [ :FACTor ] ?
```

Set the amount of data decimation done by the hardware and/or the firmware in order to decrease the number of acquired points in a long capture time. This is the amount of data that the measurement ignores. For example, if 4 is selected, three out of every four data points will be thrown away. So every 4th data point will be kept.

Factory Preset  
and \*RST: 1

Range: 1 to 4

Remarks: To use this command, the appropriate mode should be selected with INSTRUMENT:SElect.

## Control Decimation of Waveform Display

```
[ :SENSe ] :WAVeform: DECimate: STATE OFF | ON | 0 | 1
```

```
[ :SENSe ] :WAVeform: DECimate: STATE?
```

Set the decimation function on or off.

Factory Preset  
and \*RST: Off

Remarks: To use this command, the appropriate mode should be selected with INSTRUMENT:SElect.



### Waveform—Sweep (Acquisition) Time

**[ :SENSE ] :WAVEform:SWEep:TIME <time>**

**[ :SENSe ] :WAVEform:SWEep:TIME?**

Set the measurement acquisition time. It is used to specify the length of the time capture record.

Factory Preset

and \*RST: 2.0 ms

10.0 ms, for NADC, PDC

15.0 ms, for iDEN mode

Range: 1  $\mu$ s to 100 s

Default Unit: seconds

Remarks: To use this command, the appropriate mode should be selected with INSTRUMENT:SElect.

### Waveform—Trigger Source

**[ :SENSe ] :WAVEform:TRIGger:SOURce EXtErnal [1] | EXtErnal2 | FRAMe | IF | IMMEdiate | LINE | RFBurst**

**[ :SENSe ] :WAVEform:TRIGger:SOURce?**

Select the trigger source used to control the data acquisitions.

External 1 - front panel external trigger input

External 2 - rear panel external trigger input

Frame - internal frame timer from front panel input

IF - internal IF envelope (video) trigger

Immediate - the next data acquisition is immediately taken (also called free run)

Line - internal line trigger

RF Burst - internal wideband RF burst envelope trigger that has automatic level control for periodic burst signals

Factory Preset

and \*RST: Immediate (free run), for Basic, cdmaOne, NADC, PDC mode

RF burst, for GSM, iDEN mode

Remarks: To use this command, the appropriate mode should be selected with INSTRUMENT:SElect.

## Bit Error Rate Measurement

Commands for querying the bit error rate measurement results and for setting to the default values are found in the “MEASure Group of Commands” on page 138. The equivalent front panel keys for the parameters described in the following commands, are found under the **Meas Setup** key, after the **BER** measurement has been selected from the **MEASURE** key menu.

### Bit Error Rate—Averaging Termination Control

```
[[:SENSe]:BER:AVERAge:TCONtrol EXPonential|REPeat
```

```
[[:SENSe]:BER:AVERAge:TCONtrol?
```

Select the type of termination control used to averaging. This determines the averaging action after the specified number of data acquisitions (average count) is reached.

**EXPonential** – Each successive data acquisition after the average count is reached, is exponentially weighted and combined with the existing average.

**REPeat** – After reaching the average count, the averaging is reset and a new average is started.

Factory Preset: **EXPonential**

Remarks: You must be in the cdma2000, W-CDMA mode to use this command. Use **INSTRument:SELEct** to set the mode.

### Bit Error Rate—Resolution BW

```
[[:SENSe]:BER:BANDwidth|BWIDth[:RESolution] <freq>
```

```
[[:SENSe]:BER:BANDwidth|BWIDth[:RESolution]?
```

Set the demodulation resolution bandwidth. This value is ignored if the function is auto-coupled.

Factory Preset  
and \*RST: 19.53125 kHz

Factory Preset  
and \*RST: 19.53125 kHz for iDEN  
95.0 kHz for WiDEN

Remarks: You must be in the iDEN or WiDEN mode to use this command. Use **INSTRument:SELEct** to set the mode.

Front Panel  
Access: **Meas Setup, Advanced**

### Bit Error Rate—Frame Count

**[ :SENSE ] :BER:FRAMES <integer>**

**[ :SENSE ] :BER:FRAMES?**

Indicates the number of frames to be used by each test to calculate the bit error rate.

Factory Preset  
and \*RST: 16

Range: 1 to 1024 frames

Remarks: You must be in the iDEN mode to use this command.  
Use INSTRUMENT:SELEct to set the mode.

History: Version A.03.00 or later

### Bit Error Rate—Slot Count

**[ :SENSE ] :BER:SLOTS <integer>**

**[ :SENSE ] :BER:SLOTS?**

Indicates the number of slots to be used by each test to calculate the bit error rate.

Factory Preset  
and \*RST: 16

Range: 1 to 1024 frames

Remarks: You must be in the WiDEN mode to use this command.  
Use INSTRUMENT:SELEct to set the mode.

History: Version A.07.05 or later

### Bit Error Rate—PvT Test

**[ :SENSE ] :BER:PVTTest OFF | ON | 0 | 1**

**[ :SENSE ] :BER:PVTTest?**

Sets the PvT test to on or off. When this is set to On, the RF power envelope is checked against the PvT mask.

Factory Preset  
and \*RST: 0 (Off)

Range: 0 or 1 (On or Off)

Remarks: You must be in the iDEN, WiDEN mode to use this

command. Use INSTRument:SElect to set the mode.

History: Version A.03.00 or later

### Bit Error Rate—Trigger Source

**[ :SENSe ] :BER:TRIGger:SOURce**  
**EXTernal [1] | EXTernal2 | FRAME | IF | IMMEDIATE | RFBurst**

**[ :SENSe ] :BER:TRIGger:SOURce?**

Select the trigger source used to control the data acquisitions.

EXTernal 1 – front panel external trigger input

EXTernal 2 – rear panel external trigger input

IF – internal IF envelope (video) trigger

IMMEDIATE – the next data acquisition is immediately taken, capturing the signal asynchronously (also called free run)

FRAME – internal frame trigger from front panel input

RFBurst – wideband RF burst envelope trigger that has automatic level control for periodic burst signals

Factory Preset: IF for outbound

RFBurst for outbound

Remarks: You must be in the iDEN, WiDEN mode to use this command. Use INSTRument:SElect to set the mode.

### Bit Error Rate—Mask Configuration

The following Power vs. Time measurement commands are also applicable to and effective for the PvT test in BER:

**[ :SENSe ] :PVTTime:MASK:LIST:LOWer:ABSolute <power>, <power>, <power>, <power>, <power>** on page 197

**[ :SENSe ] :PVTTime:MASK:LIST:LOWer:RELative <rel\_power>, <rel\_power>, <rel\_power>, <rel\_power>** on page 198

**[ :SENSe ] :PVTTime:MASK:LIST:LOWer:TIME <seconds>, <seconds>, <seconds>, <seconds>** on page 198

**[ :SENSe ] :PVTTime:MASK:LIST:UPPer:ABSolute <power>, <power>, <power>, <power>** on page 199

**[ :SENSe ] :PVTTime:MASK:LIST:UPPer:RELative <rel\_power>, <rel\_power>, <rel\_power>, <rel\_power>** on page 200

**[ :SENSe ] :PVTTime:MASK:LIST:UPPer:TIME <seconds>, <seconds>**,

<seconds>, <seconds>, <seconds> on page 202

[[:SENSE]:PVTTime:MASK:SElect STANdard | CUSTom on page 203

For additional information on the use and parameters for these commands, refer to the command under the Power Vs. Time measurement on the pages indicated for each command.

Remarks:        You must be in the WiDEN mode to use these commands. Use INSTRument:SElect to set the mode.



## Numerics

- 12 bit Digital IF key
  - waveform measurement, 90
- 14 bit Digital IF key
  - waveform measurement, 90

## A

- Abs Limit key
  - ACPR measurement, 50
- Absolute key
  - ACPR measurement, 50
- ACP
  - limit testing, 103
  - offset frequencies, 175
  - setting amplitude levels, 173
  - testing, 186, 187
  - trigger source, 189
- ACPR
  - amplitude levels, 181, 184
  - offset frequencies, 178
  - resolution bandwidths, 176
  - testing choices, 187
- ACPR key, 45
- active license key, 36
  - how to locate, 36
- ADC Dither key
  - spectrum measurement, 84
  - waveform measurement, 91
- ADC dithering
  - SPECTrum, 218
- ADC filter
  - WAVEform, 229
- ADC range
  - SPECTrum, 218
  - WAVEform, 229
- ADC Range key
  - spectrum measurement, 83
  - waveform measurement, 90
- adjacent channel power
  - measuring, 45
- adjacent channel power measurement, 169
- adjacent channel power ratio
  - measurement, 141, 169
  - See also ACPR
- Advanced key
  - MT Avg Pwr measurement, 71
  - MT Trans EVM measurement, 76
  - PVT measurement, 67
  - waveform measurement, 90
- Advanced menu
  - spectrum, 82
- amplitude
  - input range, 193
  - maximizing input signal, 212
- AND key

- ACPR measurement, 50
- ASCII data format, 134
- attenuation
  - setting, 211
- Auto key
  - waveform measurement, 90, 91
- Auto Peak key
  - waveform measurement, 90
- AutoPeakLock key
  - waveform measurement, 90
- averaging
  - ACP, 169, 170
  - ACPR, 169, 170
  - BER, 234
  - CHPower, 191, 192
  - MotoTalk average power measurement, 204
  - OBW, 191
  - power vs. time, 194, 195
  - SPECTrum, 219, 220, 221
  - WAVEform, 230, 231
- averaging state
  - MotoTalk average power measurement, 204
- Avg Bursts key
  - MT Avg Pwr measurement, 70
- B**
- Band Power key
  - waveform measurement, 92
- band power measurement, 72, 77, 86, 92
- bandpower marker, 111
- bandwidth
  - ACPR, 170
  - BER, 234
  - MotoTalk average power measurement, 205
  - MotoTalk transient error vector magnitude measurement, 210
  - MT trans EVM measurement, 210
  - power vs. time, 195
  - PVTime, 196
  - SPECTrum, 222, 223
  - WAVEform, 231, 232
- bandwidth filter type
  - MotoTalk average power measurement, 205
  - MotoTalk transient error vector magnitude measurement, 209
- base station
  - loss correction, 189
- base station testing, 214
- BER

- averaging, 234
- frames, 235
- limit testing, 103, 235
- PvT mask configuration, 237
- trigger source, 236
- BER key, 52
- binary data order, 134
- bit error rate
  - measuring, 52
- bit error rate limits
  - BER, 103
- bit error rate measurement, 151, 234
  - See also BER
- burst carriers, 213
- Burst ID Method key
  - MT Avg Pwr measurement, 71
- Burst key
  - MT Avg Pwr measurement, 70
- burst sync delay, 228
- burst synchronization, 205
- byte order of data, 134
- C**
- Carr Est Time key
  - PVT measurement, 67
- carrier
  - type, 213
- carrier selection, 214
- CDMA measurement, 169
- cdma2000
  - ACP measurement, 173, 187
  - averaging, 234
  - trigger source, 236
  - cdma2000 measurement, 141, 155, 169
- cdmaOne
  - ACP measurement, 173, 186, 187
- cdmaOne measurement, 141
- Center
  - screen notation, 60
- Centroid Freq
  - screen notation, 60
- changing
  - instrument settings, 169
- Choose Option key, 35
- continuous carriers, 213
- continuous vs. single
  - measurement mode, 136
- control measurement commands, 136
- correction
  - base station loss, 189
  - mobile station loss, 190
- Curr power, PvT measurement, 64

curve fit the data, 104, 109  
custom masks  
PVT measurement, 67

## D

data  
querying, 104, 109  
data decimation, 223  
WAVEform, 232  
data format, 134  
data from measurements, 138  
Data Packing  
spectrum measurement, 84  
Data Packing key  
waveform measurement, 91  
Decimation  
spectrum measurement, 84  
decimation  
SPECTrum, 223  
decimation factor  
MotoTalk average power  
measurement, 206  
MotoTalk transient error vector  
magnitude measurement,  
210  
Decimation key  
MT Avg Pwr measurement, 71  
MT Trans EVM measurement,  
76  
waveform measurement, 91  
decimation of data  
WAVEform, 232  
decimation state  
MotoTalk average power  
measurement, 206  
MotoTalk transient error vector  
magnitude measurement,  
211  
default states, 26  
default values for measurements,  
139  
delay, burst sync, 228  
deleting an  
application/personality, 32  
Delta Freq  
screen notation, 60  
Delta key  
MT Avg Pwr measurement, 72  
MT Trans EVM measurement,  
76  
spectrum measurement, 85  
waveform measurement, 92  
delta markers, 114  
display  
on/off, 125  
spectrum window, 126, 131  
trace, 127

zoom, 125  
display commands, 125  
display PVT data, 126  
dithering the ADC, 218

## F

Fail key  
ACPR measurement, 50  
FFT  
SPECTrum, 224, 226  
FFT bandwidth, SPECTrum, 221,  
222  
FFT Length key, 83  
FFT Size menu, 83  
FFT Window key., 83  
format, data, 134  
format, setting spread rate, 216  
frames  
BER, 235  
Frames key  
BER measurement, 56  
frequencies offset  
ACP, 175  
frequency  
carrier setting, 214  
frequency band limits  
OBW, 120  
frequency hopping repetition  
factor  
MotoTalk transient error vector  
magnitude measurement,  
209  
frequency span  
SPECTrum, 227  
Function Off key  
MT Avg Pwr measurement, 72  
MT Trans EVM measurement,  
77  
spectrum measurement, 85  
waveform measurement, 92

## G

gate time  
MotoTalk average power, 208  
Gated & Burst key  
MT Avg Pwr measurement, 70,  
207  
Gated key  
MT Avg Pwr measurement, 70,  
207  
Gated Time key  
MT Avg Pwr measurement, 70  
GSM measurement, 194

## H

Hop Freq Ofst key

MT Trans EVM measurement,  
76

## I

I/Q waveform window, 85  
waveform view, 91  
iDEN  
ACP measurement, 173, 187  
gate time, 208  
limit testing, 235  
measurement method, 207  
sweep time, 208  
trigger source, 193  
iDEN measurement, 151, 155,  
191, 204, 208, 234  
iDEN offset frequencies, 175  
iDEN trigger source, 189, 208,  
209  
IF Align Signal menu  
Signal Amptd key, 28  
Signal Rate key, 28  
Signal Type key, 28  
IF Flatness  
advanced spectrum feature, 84  
initiate measurement, 136, 137  
input attenuation, 211  
input power  
maximum, 212  
range, 193  
Install Now key, 35  
Installing and Obtaining a license  
key, 35  
installing measurement  
personalities, 32

## K

key  
12 bit Digital IF - waveform  
measurement, 90  
14 bit Digital IF - waveform  
measurement, 90  
Abs Limit - ACPR  
measurement, 50  
Absolute - ACPR measurement,  
50  
ACPR, 45  
ADC Dither - waveform  
measurement, 91  
ADC Range - waveform  
measurement, 90  
Advanced - MT Avg Pwr  
measurement, 71  
Advanced - MT Trans EVM  
measurement, 76  
Advanced - PVT measurement,  
67



- Advanced - waveform  
Measurement, 90
- AND - ACPR measurement, 50
- Auto - waveform measurement,  
90, 91
- Auto Peak - waveform  
measurement, 90
- AutoPeakLock - waveform  
measurement, 90
- Avg Bursts- MT Avg Pwr  
measurement, 70
- Band Power, 86
- Band Power - waveform  
Measurement, 92
- Band Power- MT Trans EVM  
measurement, 77
- BER, 52
- Burst - MT Avg Pwr  
measurement, 70
- Burst ID Method - MT Avg Pwr  
measurement, 71
- Carr Est Time - PVT  
measurement, 67
- Data Packing - waveform  
measurement, 91
- Decimation - MT Avg Pwr  
measurement, 71
- Decimation - MT Trans EVM  
measurement, 76
- Decimation - waveform  
measurement, 91
- Delta - MT Avg Pwr  
measurement, 72
- Delta - MT Trans EVM  
measurement, 76
- Delta - spectrum measurement,  
85
- Delta - waveform Measurement,  
92
- Fail - ACPR measurement, 50
- Frames - BER measurement, 56
- Function Off - MT Avg Pwr  
measurement, 72
- Function Off - MT Trans EVM  
measurement, 77
- Function Off - spectrum  
measurement, 85
- Function Off - waveform  
Measurement, 92
- Gated - MT Avg Pwr  
measurement, 70, 207
- Gated & Burst - MT Avg Pwr  
measurement, 70, 207
- Gated Time - MT Avg Pwr  
measurement, 70
- Hop Freq Ofst - MT Trans EVM  
measurement, 76
- Limit - OBW measurement, 61
- Limit Test - ACPR  
measurement, 49
- Limit Test - OBW measurement,  
61
- Long (32 bit) - waveform  
measurement, 91
- Manual - waveform  
measurement, 90
- Marker - MT Avg Pwr  
measurement, 71
- Marker - MT Trans EVM  
measurement, 76
- Marker - spectrum  
measurement, 85
- Marker - waveform  
Measurement, 91
- Marker All Off - MT Avg Pwr  
measurement, 72
- Marker All Off - MT Trans EVM  
measurement, 77
- Marker All Off - spectrum  
measurement, 86
- Marker All Off - waveform  
Measurement, 92
- Meas Method - MT Avg Pwr  
measurement, 70
- Meas Time - MT Trans EVM  
measurement, 76
- Medium (24 bit) - waveform  
measurement, 91
- MT Avg Pwr, 68
- MT Trans EVM, 74
- Normal - MT Avg Pwr  
measurement, 71
- Normal - MT Trans EVM  
measurement, 76
- Normal - spectrum  
measurement, 85
- Normal - waveform  
Measurement, 92
- Occupied BW, 58
- Off - MT Avg Pwr measurement,  
72
- Off - MT Trans EVM  
measurement, 77
- Off - spectrum measurement, 86
- Off - waveform Measurement,  
92
- Offs & Limits - ACPR  
measurement, 49
- Offset BW - ACPR  
measurement, 50
- Offset Freq - ACPR  
measurement, 50
- OR - ACPR measurement, 50
- Pre-ADC BPF - waveform  
measurement, 90
- PVT, 62
- RBW Filter - MT Avg Pwr  
measurement, 71
- RBW Filter - MT Trans EVM  
measurement, 76
- RBW Filter - PVT  
measurement, 67
- RBW Filter - waveform  
measurement, 90
- Rel Lim (Car) - ACPR  
measurement, 50
- Rel Lim (PSD) - ACPR  
measurement, 50
- Relative - ACPR measurement,  
50
- Res BW - ACPR measurement,  
49
- Res BW - MT Avg Pwr  
measurement, 71
- Res BW - MT Trans EVM  
measurement, 76
- Res BW - PVT measurement, 67
- Res BW - waveform  
measurement, 90
- RF Amptd - MT Avg Pwr  
measurement, 71
- Search - waveform  
Measurement, 92
- Select 1 2 3 4 - MT Avg Pwr  
measurement, 71
- Select 1 2 3 4 - MT Trans EVM  
measurement, 76
- Select 1 2 3 4 - spectrum  
measurement, 85
- Select 1 2 3 4 - waveform  
Measurement, 91
- Shape Diamond - MT Avg Pwr  
measurement, 72
- Shape Diamond - MT Trans  
EVM measurement, 77
- Shape Diamond - spectrum  
measurement, 86
- Shape Diamond - waveform  
Measurement, 92
- Short (16 bit) - waveform  
measurement, 91
- Spectrum (Frequency Domain),  
79
- Sweep Time - waveform  
measurement, 90
- Sync Word - MT Avg Pwr  
measurement, 71
- Trace Spectrum - MT Avg Pwr  
measurement, 72

- Trace Spectrum - MT Trans EVM measurement, 77
  - Trace Spectrum - spectrum measurement, 85
  - Trace Spectrum - waveform Measurement, 92
  - Trace/View - waveform Measurement, 91
  - Waveform (Time Domain), 87
- L**
- Length Ctrl key, 83
  - Length key, 83
  - license key
    - obtaining and installing, 35
  - Limit key
    - OBW measurement, 61
  - Limit Test key
    - ACPR measurement, 49
    - OBW measurement, 61
  - limit testing, 104
    - ACP, 103
    - BER, 103, 235
    - NADC, 103
    - OBW, 120, 122
    - PDC, 103
  - loading an
    - application/personality, 32
  - Long (32 bit) key
    - waveform measurement, 91
- M**
- Manual key
    - waveform measurement, 90
  - Marker All Off key
    - MT Avg Pwr measurement, 72
    - MT Trans EVM measurement, 77
    - spectrum measurement, 86
    - waveform measurement, 92
  - Marker key
    - MT Avg Pwr measurement, 71
    - MT Trans EVM measurement, 76
    - spectrum measurement, 85
    - waveform measurement, 91
  - markers, 110
    - assigning them to traces, 115
    - bandpower, 111
    - maximum, 113
    - minimum, 113
    - noise, 111
    - off, 111, 114
    - trace assignment, 119
    - turn off, 111
    - type, 114
    - valid measurement, 110
  - value, 120
  - value of, 112
  - x-axis location, 119
  - y-axis, 120
- masks
  - power vs. time, 197, 198, 199, 200, 202, 203, 214, 216, 217
- maximum value of trace data, 104, 109
  - Mean Transmit Pwr, PvT measurement, 63, 64
  - mean value of trace data, 104, 109
  - Meas Method key
    - MT Avg Pwr measurement, 70
  - Meas Time key
    - MT Trans EVM measurement, 76
  - measurement
    - adjacent channel power, 45, 169
    - adjacent channel power ratio, 169
    - bit error rate, 52, 234
    - markers, 110
    - MotoTalk average power, 204
    - MotoTalk power average, 68
    - MotoTalk transient error vector magnitude measurement, 208
    - MotoTalk transient EVM, 74
    - occupied bandwidth, 58
    - occupied BW, 191
    - power vs time, 62
    - power vs. time, 194
    - spectrum (frequency domain), 79, 217
    - waveform (time domain), 87, 229
  - measurement method
    - MotoTalk average power measurement, 207
  - measurements
    - adjacent channel power ratio, 141
    - bit error rate, 151
    - configuration, 138
    - control of, 136
    - getting results, 138
    - MotoTalk average power, 162
    - MotoTalk transient error vector magnitude, 163
    - MT avg pwr, 162
    - MT trans EVM, 163
    - occupied BW, 155
    - power vs. time, 157
    - single/continuous, 136
    - spectrum (frequency domain), 164
  - waveform (time domain), 166
- Medium (24 bit) key
  - waveform measurement, 91
- Min Pts in RBW key, 83
  - minimum value of trace data, 104, 109
  - missing options, 32
  - mobile station
    - loss correction, 190
  - mobile station testing, 214
  - MotoTalk average power
    - burst synchronization, 205
    - measurement method, 207
  - MotoTalk average power measurement, 162, 204
    - averaging state, 204
    - bandwidth filter type, 205
    - decimation factor, 206
    - decimation state, 206
    - number of bursts averaged, 204
    - resolution bandwidth, 205
    - trigger source, 208
    - See also MT Avg Pwr
  - MotoTalk average power measurement sweep time
  - MotoTalk average power measurement gate time, 208
  - MotoTalk power average measuring, 68
  - MotoTalk transient error vector magnitude measurement, 163, 208
    - bandwidth filter type, 209
    - decimation factor, 210
    - decimation state, 211
    - frequency hopping repetition factor, 209
    - repetition factor - frequency hopping, 209
    - resolution bandwidth, 210
    - trigger source, 209
    - See also MT Trans EVM
  - MotoTalk transient EVM measuring, 74
  - MT Avg Pwr key, 68
  - MT avg pwr measurement, 162
  - MT Trans EVM key, 74
  - MT trans EVM measurement, 163
    - resolution bandwidth, 210
- N**
- NADC
    - burst power threshold, 228
    - offset frequencies, 175
    - trigger source, 189

- NADC measurement, 169  
noise marker, 111  
Normal key  
  MT Avg Pwr measurement, 71  
  MT Trans EVM measurement, 76  
  spectrum measurement, 85  
  waveform measurement, 92  
normal marker, 114
- O**
- OBW  
  limit testing, 120, 122  
  percent power, 192  
  trigger source, 193  
OBW averaging, 191  
occupied bandwidth  
  measuring, 58  
Occupied BW key, 58  
occupied BW measurement, 155, 191  
  See also OBW  
Off key  
  MT Avg Pwr measurement, 72  
  MT Trans EVM measurement, 77  
  spectrum measurement, 86  
  waveform measurement, 92  
Offs & Limits key  
  ACPR measurement, 49  
Offset BW key  
  ACPR measurement, 50  
Offset Freq key  
  ACPR measurement, 50  
offset frequencies, 186  
  ACP, 175  
options  
  loading/deleting, 32  
options not in instrument  
  memory, 32  
OR key  
  ACPR measurement, 50
- P**
- packing  
  SPECTrum, 218  
pass/fail test, 104  
PDC  
  burst power threshold, 228  
  offset frequencies, 175  
  trigger source, 189, 193  
PDC measurement, 155, 169, 191  
percent power, OBW, 192  
personality options not in instrument, 32  
power  
  % occupied power bandwidth, 192  
  power vs time  
    measuring, 62  
  power vs. time - averaging type, 195  
  power vs. time - custom limit masks, 203  
  power vs. time - lower mask  
    absolute amplitude levels, 197  
  power vs. time - lower mask points, 198  
  power vs. time - lower mask relative amplitude levels, 198  
  power vs. time - lower mask time points, 199  
  power vs. time - number of bursts averaged, 194  
  power vs. time - resolution bandwidth, 195  
  power vs. time - trigger source, 203  
  power vs. time - upper mask  
    absolute amplitude levels, 199  
  power vs. time - upper mask points, 200  
  power vs. time - upper mask relative amplitude levels, 200, 214, 216, 217  
  power vs. time - upper mask time points, 202  
  power vs. time measurement, 157, 194  
    See also PVTime  
  pre-ADC bandpass filter SPECTrum, 221  
  Pre-ADC BPF key  
    spectrum measurement, 82  
    waveform measurement, 90  
  pre-FFT bandwidth, SPECTrum, 221, 222  
  Pre-FFT BW key, 82  
  Pre-FFT Fltr key, 82  
  preset states, 26  
  PVT  
    view of data, 126  
  PVT key, 62  
  PvT mask configuration  
    BER, 237  
  PvT measurement, curr power, 64  
  PvT measurement, Mean Transmit Pwr, 63, 64  
  PvT measurement, SGC correction factor, 64  
  PVTime  
    bandwidth, 196
- Q**
- query data, 104, 109
- R**
- radio format setting, 216  
RBW Filter key  
  MT Avg Pwr measurement, 71  
  MT Trans EVM measurement, 76  
  PVT measurement, 67  
  waveform measurement, 90  
real number data format, 134  
Rel Lim (Car) key  
  ACPR measurement, 50  
Rel Lim (PSD) key  
  ACPR measurement, 50  
Relative key  
  ACPR measurement, 50  
repetition factor  
  frequency hopping, MotoTalk  
  transient error vector  
  magnitude measurement, 209  
Res BW key  
  ACPR measurement, 49  
  MT Avg Pwr measurement, 71  
  MT Trans EVM measurement, 76  
  PVT measurement, 67  
  spectrum measurement, 82  
  waveform measurement, 90  
restart measurement, 137  
results from measurements, 138  
return data, 104, 109  
RF Amptd key  
  MT Avg Pwr measurement, 71  
RF Envelope key, 91  
RMS of trace data, 104, 109
- S**
- sampling trace data, 104, 109  
screen notation  
  center, 60  
  centroid freq, 60  
  delta freq, 60  
Search key  
  waveform measurement, 92  
Select 1 2 3 4 key  
  MT Avg Pwr measurement, 71  
  MT Trans EVM measurement, 76  
  spectrum measurement, 85  
  waveform measurement, 91  
setting default values, 139

- SGC Corr, PvT measurement, 64
  - Shape Diamond key
    - MT Avg Pwr measurement, 72
    - MT Trans EVM measurement, 77
    - spectrum measurement, 86
    - waveform measurement, 92
  - Short (16 bit) key
    - waveform measurement, 91
  - single vs. continuous measurement mode, 136
  - span
    - SPECTrum, 227
  - Span key
    - spectrum measurement, 82
  - SPECTrum
    - acquisition packing, 218
    - ADC range, 218
    - data decimation, 223
    - FFT length, 224
    - FFT resolution BW, 224
    - FFT window, 226
    - frequency span, 227
    - trigger source, 227
  - spectrum (frequency domain) measuring, 79
  - Spectrum (Frequency Domain) key, 79
  - spectrum (frequency domain) measurement, 164, 217
    - See also SPECTrum
  - spectrum measurement display, 126, 131
  - spectrum window, 85
  - spread rate setting, 216
  - standard deviation of trace data, 104, 109
  - start measurement, 136, 137
  - state
    - changing, 169
  - sweep time
    - MotoTalk average power measurement, 208
    - WAVEform, 233
  - Sweep Time key
    - waveform measurement, 90
  - Sync Word key
    - MT Avg Pwr measurement, 71
  - synchronization
    - burst sync delay, 228
    - MotoTalk average power, 205
    - NADC, 228
    - PDC, 228
  - T**
    - test limit
      - BER, 103
    - OBW, 120, 122
    - test limits, 104
      - NADC, 103
      - PDC, 103
    - time domain measurement, 166, 229
    - total, bit error rate, 55
    - trace data
      - processing, 104, 109
    - trace display, 127
    - trace format, 134
    - trace names for markers, 115
    - Trace Spectrum key
      - MT Avg Pwr measurement, 72
      - MT Trans EVM measurement, 77
      - spectrum measurement, 85
      - waveform measurement, 92
    - Trace/View key
      - waveform measurement, 91
    - trigger
      - power vs. time, 203
      - SPECTrum, 227
      - WAVEform, 233
    - trigger measurement, 136, 137
    - trigger source
      - ACP, 189
      - BER, 236
      - MotoTalk average power measurement, 208
      - MotoTalk transient error vector magnitude measurement, 209
      - OBW, 193
  - U**
    - Uninstall Now, 36
    - uninstalling measurement personalities, 32
  - V**
    - view commands, 125
    - view PVT data, 126
  - W**
    - WAVEform
      - ADC filter, 229
      - ADC range, 229
      - data decimation, 232
      - sweep time, 233
      - trigger source, 233
    - waveform (time domain) measuring, 87
    - Waveform (Time Domain) key, 87
    - waveform (time domain) measurement, 166, 229
  - See also WAVEform
  - W-CDMA
    - ACP measurement, 173, 187
    - averaging, 234
    - trigger source, 236
  - W-CDMA (3GPP) measurement, 155
  - W-CDMA measurement, 141, 169
  - window
    - I/Q waveform, 85
    - spectrum, 85
  - Window Length key, 83
  - word, bit error rate, 55
- Z**
- zero span measurement, 166, 229
  - zoom the display, 125